

Singer 81-70
Singer 81-73
Singer 81-76

Form 19040
(337)
Printed in U. S. A.

LIST OF PARTS



MACHINES
Nos. 81-70, 81-73 and 81-76

THE SINGER MANUFACTURING COMPANY

INSTRUCTIONS FOR OILING

USE SINGER "OIL FOR HIGH SPEED SEWING MACHINES (Cloth and Leather)" or "STAINLESS OIL FOR HIGH SPEED SEWING MACHINES".

Before starting the machine, open the frame side cover and apply oil to the oil cup in the bed of the machine, also to the oil hole under the arm, until the reservoirs are full. Fill the oil cup at the top of the machine and thoroughly saturate the wick through the hole in the casting near the top of the needle bar. Then oil the needle bar link connection at the front of the machine. Also apply oil to the knife lever and presser lever bearings at the back of the machine.

THEREAFTER, replenish the oil supply in the reservoirs about once each day, or often enough to keep them filled. Twice a day apply oil to the remainder of the oiling points.

The surplus oil drips into the cast iron base and this oil should be occasionally drained by turning the tap which is provided in the base for this purpose.

CAUTION: A machine new from the factory, or one that has not been used for some time, should not be operated until about three hours after filling the reservoirs.

Failure to heed this caution may result in serious damage to the machine.

Copyright, U. S. A., 1932, 1935, 1936 and 1937,
by The Singer Manufacturing Co.
All Rights Reserved for all Countries

INDEX

	Page
Accessories.....	39
Bench Stands.....	39
Fittings for 81-70 Machine.....	14-15
Fittings for 81-73 Machine.....	25-26-27-28
Foot Lifter Parts.....	40
Knee Lifter Parts.....	41
Knife Grinder, for 81-70 and 81-73 Machines.....	42
Knife Grinder, for 81-76 Machine.....	42
Machine Bases.....	43
Machine Base Oil Drain Jars.....	44
Machine No. 81-70.....	5
Machine No. 81-73.....	16
Machine No. 81-76.....	29
Numerical List of Parts.....	47
Thread Unwinder.....	45

From the library of: Diamond Needle Corp

INSTRUCTIONS FOR ORDERING

In ordering from this list, use **ONLY** the part **NUMBER** in the **FIRST** column.

The number stamped on a Sewing Machine Part is in every case the number of the single part only.

Every combination of parts sent out as such has its specific number, which, although not stamped on the parts, must be used when ordering the combination.

Each number always indicates the **SAME PART** in whatever list it appears, or for whatever machine.

The letters after some of the numbers indicate the style of finish only, as follows:

A-Hardened, Polished, Nickel Plated and Buffed

B-Polished, Nickel Plated and Buffed

C-Hardened Only

D-Polished Only

E-Soft, Not Polished

F-Hardened and Polished

F.J-Hardened, Polished and Nickel Plated

G-Bright Rumbled and Nickel Plated

H-Blued

J-Nickel Plated Only

K-Hardened and Nickel Plated

L-Brass Plated

M-Oxidized

N-Japanned, Dull

P-Japanned, Bright

R-Merlized

S-Cadmium Plating

T-Copper Plated

T.A-Hardened, Polished, Copper and Nickel Plated and Buffed

T.B-Copper and Nickel Plated and Polished

T.J-Copper and Nickel Plated Only

T.K-Hardened, Copper and Nickel Plated

T.M-Copper Plated and Oxidized

T.L-Copper and Brass Plated

U-Zinc Plated

V-Silver Plated

W-Polished and Nickel Plated

Y-Black Nickel Plated Only

Z-Chromium Plated

Z.B-Polished, Nickel Plated, Buffed and Chromium Plated

Z.J-Nickel and Chromium Plated

These letters **MUST BE USED** when they appear in the list; and **AFTER** the number as in the list.

In this series:

1 to 1500, 50001 to 51500 and 140001 to 142000 are Screw Numbers

1501 to 1800 and 51501 to 51800 are Nut Numbers

1801 to 2000 and 51901 to 52000 are Roller Number

2001 to 50000 and 52001 to 140000 and 142001 to

190000 are Sewing Machine Parts, 190001 and upward

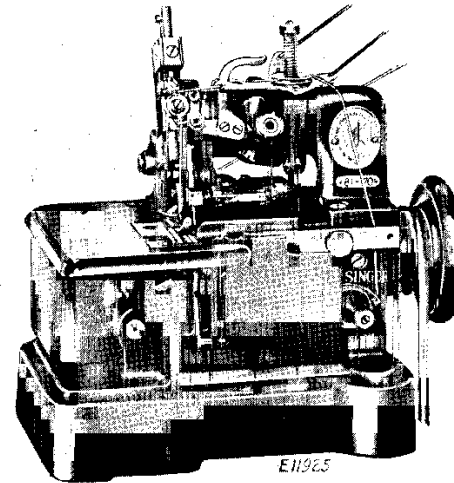
are numbers of Electrical Parts.

The figures in the second column refer only to the plates, illustrating the parts, and are **NOT TO BE USED** in ordering.

Parts marked with an asterisk (*) are furnished only when repairs are made at factory.

LIST OF PARTS COMPLETE

FOR



MACHINE No. 81-70

For Trimming, Overedging and Closing Seams in Light and Medium Weight Knit Goods and Rayon, Bight adjustable from 1/8 to 3/16 inch on knit material and 3/32 to 5/32 inch on rayon. Three-thread stitch. Foot lifter. Gathering feed. Needle bar stroke 7/16 inch. Will stitch material up to 3/16 inch in thickness. Speed 4500 R. P. M. for long runs.

No.	Plate	Name
*132522	-----	Arm, with 15404, 42253, 132580 and two each 462C, 624C, 15405 and 132589.....
4389	20821	Arm Dowel Pin.....
68350	20821	" Oil Cup.....
949E	20846	" Screw.....
132632	20855	Balance Wheel, 1 7/8 in. pulley with 446C and 1285C.....
1285C	20807	Balance Wheel Position Screw.....
446 C	7409	" " Set Screw.....
132654	20855	Chip Guard.....
132524	20808	Cloth Plate with 132525.....
132601	20808	" " Extension (lower).....
233E	20816	" " " " Screw.....

PARTS FOR MACHINE No. 81-70

No.	Plate	Name
42108	20821	Cloth Plate Extension (upper).....
233E	20816	" " " " " Screw.....
*132525	-----	" " " Hinge Bracket.....
132526	20821	" " " Stud.....
50150C	20821	" " " " Set Screw.....
42005	20821	" " " Lock Spring.....
236C	20821	" " " " Screw.....
132527	-----	Cloth Plate complete, Nos. 42005, 42108, 132524, 132601, two 236C and five 233E
42147	7406	Feed (back) Bar.....
61C	7406	" " " " Hinge Screw.....
42148	7406	" " " Connecting Link.....
1132C	7406	" " " " Hinge Screw.....
42149	20816	" " " Dog, 3 teeth (16 teeth to the inch) for knit goods, for 132858....
193E	20856	Feed (back) Dog Screw.....
42150	7406	" " " Regulator.....
1132C	7406	" " " Hinge Screw.....
190J	20846	" " " Set Screw.....
1444C	7406	" " " Thumb Screw.....
42151	7406	" (front) Bar with 1253C.....
132624	-----	" " 42151 with 61C, 42147, 42148, 42150, 132528, 132539, 132541 and two 1132C.....
132528	7406	Feed (front) Bar Hinge Pin.....
1253C	20846	" " " " Set Screw....
132529	7407	" " " Connecting Rod with 171C, 1695J and two 1057C.....
132619	-----	Feed (front) Connecting Rod 132529 with 132534.....
1057C	7407	Feed (front) Connecting Rod Cap Screw....
51292C	7407	" " " " Hinge Screw.....
171C	7407	" " " " " " " " Clamping Screw.....
1695J	7407	Feed (front) Connecting Rod Hinge Screw Clamping Screw Nut.....
1520J	5569	Feed (front) Connecting Rod Hinge Screw Nut.....
132855	20856	Feed (front) Dog, 22 teeth (16 teeth to the inch) for knit goods, for 132858
193E	20856	Feed (front) Dog Screw.....
*132531	-----	" " " Eccentric.....
*132702	-----	" " " " Body.....
1036C	5569	" " " " Set Screw....
19047	7407	" " " " Clamping Washer...
201J	7407	" " " " " Screw.....
132533	7407	" " " " Oil Tube.....
132534	7407	Feed (front) Eccentric complete, Nos. 201J 19047, 51145C, 132531, 132533, 132702 and two 1036C.....

PARTS FOR MACHINE No. 81-70

No.	Plate	Name
132651	7407	Feed (front) Eccentric Cover.....
50253J	7407	" " " " " Screw.....
132712	20858	" " " " Lint Cover (spring)
132785	20858	" " " " Lubricator with 132537.....
132537	20858	Feed (front) Eccentric Lubricator Oil Wick (braided cotton).....
132649	20858	Feed (front) Lifting Eccentric with two 462C.....
132539	20858	Feed (front) Lifting Eccentric Connection.....
462C	20846	Feed (front) Lifting Eccentric Set Screw
51145C	7407	" " " Regulating Screw.....
132540	7406	" " " Rock Shaft.....
132541	-----	Feed (front) Rock Shaft complete, Nos. 1444C, 42021 and 132540.....
42021	20858	Feed (front) Rock Shaft Crank with 157E
157E	5569	" " " " " Clamping Screw.....
132542	20859	Feed (front) Rock Shaft Hinge Pin with 132544.....
132543	20859	Feed (front) Rock Shaft Hinge Pin Bushing.....
132816	20823	Feed (front) Rock Shaft Hinge Pin Bushing Oil Wick (wick).....
1036C	5569	Feed (front) Rock Shaft Hinge Pin Bushing Set Screw.....
132544	20859	Feed (front) Rock Shaft Hinge Pin Oil Wick (braided cotton).....
*132545	-----	Frame.....
132546	20808	" Bottom Cover with 132594.....
132547	20808	" " " Gasket.....
190E	20846	" " " " Screw.....
132548	20821	" Oil Cup.....
132819	20855	" Rotary Shaft with 132558 and 132559.....
132820	-----	Frame Rotary Shaft 132819 with 132774, 132790, 132802 and 132806.....
132790	20834	Frame Rotary Shaft Ball Sleeve.....
132774	20817	" " " " Guide.....
*132862	-----	" " " " Bushing (front).....
132863	20817	" " " " " " 132862 with 132835, 132864 and two 132715....
132864	20823	Frame Rotary Shaft Bushing (front) Oil Pad (braided cotton).....
132715	20817	Frame Rotary Shaft Bushing (front) Oil Pad Retainer.....
132817	20823	Frame Rotary Shaft Bushing (front) Oil Wick (wick).....
51332C	20821	Frame Rotary Shaft Bushing (front) Set Screw.....

PARTS FOR MACHINE No. 81-70

No.	Plate	Name
132769	20817	Frame Rotary Shaft Crank with 1036C, 1375C and 132773.....
132770	20817	Frame Rotary Shaft Crank Ball Sleeve.....
132771	20817	" " " " " Bushing.....
1664E	20817	Frame Rotary Shaft Crank Ball Sleeve Bushing Nut.....
132772	20817	Frame Rotary Shaft Crank Ball Sleeve Bushing Nut Washer.....
132773	20846	Frame Rotary Shaft Crank Ball Sleeve Bushing Position Pin.....
132774	20817	Frame Rotary Shaft Crank Ball Sleeve Guide.....
1375C	20817	Frame Rotary Shaft Crank Position Screw.....
1036C	5569	" " " " Set Screw.....
132775	-----	Frame Rotary Shaft Crank complete, Nos. 1664E and 132769 to 132772.....
132835	20817	Frame Rotary Shaft Crank Oil Sling Cover
132865	20855	" " " Flanged Bushing (back)
132866	-----	" " " " " 132865 with 132692, 132867, 132868 and two 132603.....
132867	20823	Frame Rotary Shaft Flanged Bushing(back) Oil Pad (large).....
132868	20823	Frame Rotary Shaft Flanged Bushing(back) Oil Pad (small) braided cotton.....
132603	20834	Frame Rotary Shaft Flanged Bushing(back) Oil Pad Retainer.....
132817	20823	Frame Rotary Shaft Flanged Bushing(back) Oil Wick (wick).....
51332C	20821	Frame Rotary Shaft Flanged Bushing(back) Set Screw.....
132558	20823	Frame Rotary Shaft Oil Pad (braided cotton).....
132559	20823	Frame Rotary Shaft Oil Pad Retainer.....
132692	20834	" " " " Sling Cover.....
132560	20855	" Side Cover (left) with 132701.....
132701	20821	" " " " Handle.....
330W	20821	" " " " Screw.....
42028	20855	" " " (right) hinged.....
42101	20821	" " " " Lock Spring....
330W	20821	" " " " Screw.....
132780	20808	" Top Cover.....
132781	-----	" " " 132780 with 132782 to 132784 and two 197J.....
132650	7409	Frame Top Cover Extension.....
42102	7409	" " " " Holder.....
132600	-----	" " " " " 42102 with 42101, 132650, 132651 and two each 176J and 50253J.....

PARTS FOR MACHINE No. 81-70

No.	Plate	Name
283W	7409	Frame Top Cover Extension Holder Thumb Screw.....
19044	7407	Frame Top Cover Extension Holder Thumb Screw Washer.....
176J	20846	Frame Top Cover Extension Screw.....
132782	20821	" " " Oil Reservoir Cover.....
197J	20846	" " " " " Screw.....
132783	20821	" " " " Tube.....
132784	20821	" " " " Wick.....
583F	20846	" " " Screw (large).....
742F	20846	" " " " (small).....
42305	20818	Knife (movable).....
Note: Two No. 42305 are sent with this machine.		
42306	20818	Knife (movable) Gib.....
42307	20818	" " " Holder.....
42308	-----	" " " 42307 with 133F, 42040 and 42306.....
42038	7409	Knife (movable) Holder Guide with 336F..
42039	7409	" " " " " Plate.....
621E	7409	" " " " " Screw..
336F	7409	" " " " " Set Screw..
133F	7409	" " " " " Screw.....
42040	7409	" " " " " Extension Pin.....
42041	7409	Knife (movable) Holder Spring.....
132821	20834	" " " Lever with 175E.....
132563	20834	" " " " Connection with two 1057C.....
132620	-----	Knife (movable) Lever Connection 132563 with 132649.....
1057C	7407	Knife (movable) Lever Connection Cap Screw.....
132565	20834	Knife (movable) Lever Connection Hinge Stud.....
175E	20846	Knife (movable) Lever Connection Hinge Stud Set Screw.....
42045	20834	Knife (movable) Lever Hinge Stud.....
1229C	20846	" " " " " Set Screw
42309	20818	" (stationary) with 42049.....
Note: Two No. 42309 are sent with this machine.		
42310	20818	Knife (stationary) Clamping Stud.....
1534D	20818	" " " " Thumb Nut.....
132767	20818	Knife (stationary) Holder.....
1376C	20818	" " " " Regulating Thumb Screw.....
1101C	20807	Knife (stationary) Holder Screw.....
440C	7409	" " " " Stop Screw....
1547J	7409	" " " " " Nut
42049	20818	" " " Stud.....

PARTS FOR MACHINE No. 81-70

No.	Plate	Name
42050	20861	Looper (left hand).....
50117C	20846	" " " Clamping Screw.....
132795	20861	" " " Lever with 50117C.....
132796	20861	" " " " Connecting Link.
132797	20861	" " " " " "
		Hinge Pin.....
51459E	20861	Looper (left hand) Lever Connecting Link Screw.....
1735J	20861	Looper (left hand) Lever Connecting Link Screw Nut.....
132798	20861	Looper (left hand) Lever Hinge Stud with 132552.....
132552	20861	Looper (left hand) Lever Hinge Stud Oil Pad (braided cotton).....
132816	20823	Looper (left hand) Lever Hinge Stud Oil Wick (wick).....
1036C	5569	Looper (left hand) Lever Hinge Stud Set Screw.....
132830	20862	Looper (right hand).....
132799	20862	" " " and Spreader Lever with 233E, 241E and 140123C.....
132800	-----	Looper (right hand) and Spreader Lever 132799 with 132899.....
132801	-----	Looper (right hand) and Spreader Lever 132800 with 42242, 132795, 132798 and two each 1735J, 51459E, 132796 and 132797.....
132802	20817	Looper (right hand) and Spreader Lever Ball Stud.....
140123C	20846	Looper (right hand) and Spreader Lever Ball Stud Set Screw.....
132777	20817	Looper (right hand) and Spreader Lever Connection with four 896C.....
132779	-----	Looper (right hand) and Spreader Lever Connection 132777 with 132774, 132775 and 132802.....
896C	20817	Looper (right hand) and Spreader Lever Connection Cap (lower) Screw.....
896C	20817	Looper (right hand) and Spreader Lever Connection Cap (upper) Screw.....
132899	20862	Looper (right hand) and Spreader Lever Hinge Pin with 125056.....
132543	20859	Looper (right hand) and Spreader Lever Hinge Pin Bushing.....
132816	20823	Looper (right hand) and Spreader Lever Hinge Pin Bushing Oil Wick (wick)...
1036C	5569	Looper (right hand) and Spreader Lever Hinge Pin Bushing Set Screw.....
125056	20862	Looper (right hand) and Spreader Lever Hinge Pin Oil Wick (braided cotton).

PARTS FOR MACHINE No. 81-70

No.	Plate	Name
1036C	5569	Looper (right hand) and Spreader Lever Hinge Pin Set Screw.....
241E	20846	Looper (right hand) and Spreader Lever Oil Plug Screw.....
197J	20846	Looper (right hand) Screw.....
42054	20863	Needle Bar.....
42253	20863	" " Bushing (lower).....
132580	20863	" " " (upper).....
132581	20863	" " " Oil Pad (braided cotton).....
132821	20863	Needle Bar Bushing (upper) Oil Pad Cover
217J	20846	" " " " " " "
		Screw.....
462C	20846	Needle Bar Bushing Set Screw.....
132598	20863	" " " Connecting Bracket with 187E and 223F.....
187E	20846	Needle Bar Connecting Bracket Clamping Screw.....
132582	20863	Needle Bar Connecting Link.....
132583	20863	" " " " Hinge Pin with 132584.....
132584	20863	Needle Bar Connecting Link Hinge Pin Oil Pad (wick).....
223F	20846	Needle Bar Connecting Link Hinge Pin Set Screw, for 132598.....
620C	20846	Needle Bar Connecting Link Hinge Pin Set Screw, for 132890.....
132806	20864	Needle Bar Connecting Rod with four 896C
896C	20817,	" " " " Cap (lower)
		Screw.....
896C	20817	Needle Bar Connecting Rod Cap, (upper)
		Screw.....
132879	20864	Needle Bar Crank (back) with 132590 and two 1259C.....
132802	20817	Needle Bar Crank (back) Ball Stud.....
1259C	20846	" " " " " " Set Screw.....
132589	20864	Needle Bar Crank (back) Bushing.....
624C	20846	" " " " " Set Screw.
132590	20864	" " " " Oil Pad (wick)..
1259C	20846	" " " " Set Screw.....
132880	20864	" " " (front) with 620C, 50200C and 140123C.....
132882	-----	Needle Bar Crank (front) 132880 with 132582, 132598 and two 132583.....
140123C	20846	Needle Bar Crank (front) Position Screw.
50200C	20846	" " " " Set Screw.....
42115	20863	" " Thread Retainer Bracket.....
42453	20863	" " " " Disc.....
93C	20846	" " " " Screw.....

No.	Plate	Name
742F	20846	Throat Plate Screw.....
*15404	-----	Trade Mark.....
15405	-----	" " Rivet.....

PARTS REQUIRED FOR TWO-THREAD STITCH

No.	Plate	Name
228J	20846	Needle Bar Thread Retainer Bracket Screw
132831	20862	Spreader, in place of Looper (right hand) 132630.....
42082	20866	Tension (needle thread) Thread Guide, in place of 132875.....
42096	20866	Thread (needle) Eyelet, in place of 132873.....
132883	20866	Thread (needle) Take-up, in place of 132914.....

FITTINGS
FOR RAYON

No.	Plate	Name
132859	20853	Feed Dog, 35 teeth (22 teeth to the inch) for 132861.....
132608	20853	Presser Foot Chaining-off Finger.....
233J	20816	" " " " Screw..
132609	20868	" " " " Plate.....
132610	20868	" " " " Collar with 240C.....
132611	20868	Presser Foot Chaining-off Plate Collar Guide Pin.....
735C	20846	Presser Foot Chaining-off Plate Collar Guide Pin Set Screw.....
240C	20846	Presser Foot Chaining-off Plate Collar Set Screw.....
14058	20816	Presser Foot Chaining-off Plate Spring..
42461	20856	" " Hinge Pin.....
132683	-----	" " Plate.....
132685	-----	" " Shank with 735C.....
132860	20853	Presser Foot (spring hinged) complete, Nos. 233J, 14058, 42461, 132608 to 132611, 132683 and 132685.....
132861	20853	Throat Plate, for 132859.....

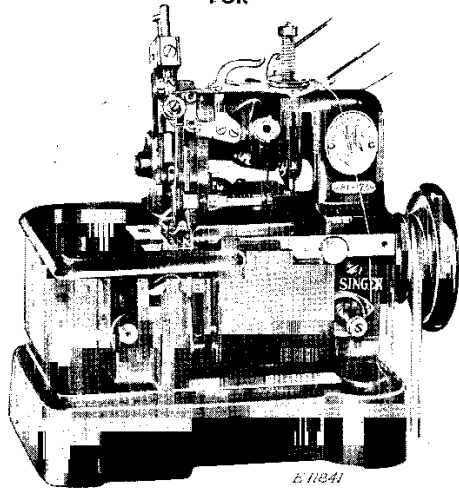
FITTINGS FOR LIGHT KNIT MATERIAL,
SUCH AS SILK, BALBRIGGAN UNDERWEAR, ETC.

No.	Plate	Name
42492	20867	Feed (back) Dog, 4 teeth (22 teeth to the inch) for 132903.....
42491	20867	Feed (front) Dog, 29 teeth (22 teeth to the inch) for 132903.....
42288	20867	Presser Foot Chaining-off Finger.....
233J	20816	" " " " Screw..
42405	20856	" " Plate (back).....
9320	20816	" " " " Hinge Pin.....
14058	20816	" " " " Spring.....
42160	20816	" " " " Adjust- ing Pin.....
464C	20816	Presser Foot Plate (back) Spring Adjust- ing Pin Set Screw.....
132856	-----	Presser Foot Plate (front).....
42461	20856	" " " " Hinge Pin.....
42264	-----	" " Shank.....
132904	20867	Presser Foot (spring hinged) complete, Nos. 233J, 464C, 9320, 14058, 42160, 42264, 42288, 42405, 42461 and 132856.....
132903	20867	Throat Plate, for 42491 and 42492.....

Genuine Singer Needles should be used in Singer Machines. These Needles and their Containers are marked with the Company's Trade Mark "SIMANCO." 1

Needles in Containers marked "For Singer Machines" are not Singer made needles. 2

LIST OF PARTS COMPLETE
FOR



MACHINE No. 81-73

For Trimming, Overedging and Closing Seams in Light and Medium Weight Knit Materials and Rayon. Bight adjustable from 1/8 to 3/16 inch. Can also be fitted for 3/16 to 1/4 inch bight on knit material and 1/16 and 3/32 to 5/32 inch for rayon. Three-thread stitch. Foot lifter. Gathering feed. The front and rear feed dogs rise and fall simultaneously and can be adjusted by a hand lever at the back of the machine to regulate the fullness of the gathering in sweater material, or for rayon material where gathering is not required. Needle bar stroke 7/8 inch. Will stitch material up to 3/16 inch in thickness. Speed 4500 R. P. M. for long runs.

No.	Plate	Name
*132522	-----	Arm with 15404, 42253, 132580 and two each 462C, 824C, 15405 and 132589.....
4389	20821	Arm Dowel Pin.....
68350	20821	" Oil Cup.....
949E	20846	" Screw.....
132632	20855	Balance Wheel, 1 7/8 in. pulley, with 446C and 1285C.....

PARTS FOR MACHINE No. 81-73

No.	Plate	Name
1285C	20807	Balance Wheel Position Screw.....
446C	7409	" " Set Screw.....
132654	20855	Chip Guard.....
132524	20808	Cloth Plate with 132525.....
132601	20808	" " Extension (lower).....
233E	20816	" " " Screw.....
42108	20821	" " " (upper).....
233E	20816	" " " Screw.....
*132525	-----	" " Hinge Bracket.....
132526	20821	" " Stud.....
50150C	20821	" " " Set Screw.....
42005	20821	" " Lock Spring.....
236C	20821	" " " Screw.....
132527	-----	Cloth Plate complete, Nos. 42005, 42108, 132524, 132601, two 236C and five 233E
132665	20860	Feed (back) Bar.....
1132C	7406	" " " Hinge Screw.....
132666	20860	" " " Pin (hollow).....
132667	20860	" " Connecting Link.....
132838	20868	" " Dog (16 teeth to the inch) for knit goods, for 132689 and 132920
193E	20856	Feed (back) Dog Screw.....
132837	20857	" " Regulator.....
69F	20857	" " " Hinge Screw.....
132838	20857	" " " Indicator.....
240J	20846	" " " Screw.....
132839	20857	" " " Rack.....
132840	*20857	" " " Pawl.....
1430C	20857	" " " " Hinge Screw
132841	20857	" " " " Spring.....
132671	20857	" (front) Bar with 1253C.....
*132842	-----	" " " 132671 with 69F, 1132C, 1430C, 132528, 132539, 132665 to 132667 132837 to 132841, 132845 and two 240J
132528	7406	Feed (front) Bar Hinge Pin.....
1253C	20846	" " " " Set Screw....
132529	7407	" " Connecting Rod with 171C, 1695J and two 1057C.....
132643	-----	Feed (front) Connecting Rod 132529 with 132644.....
1057C	7407	Feed (front) Connecting Rod Cap Screw...
51292C	7407	" " " " Hinge Screw.
171C	7407	" " " " " "
		Clamping Screw.....
1695J	7407	Feed (front) Connecting Rod Hinge Screw
		Clamping Screw Nut.....
1520J	5569	Feed (front) Connecting Rod Hinge Screw
		Nut.....
132843	20868	Feed (front) Dog (16 teeth to the inch) for knit goods, for 132689 and 132920

From the Library of: [Digitallibrary.org](http://www.digitallibrary.org)

PARTS FOR MACHINE No. 81-73

No.	Plate	Name
190E	20846	Feed (front) Dog Screw.....
*132531	-----	" " Eccentric.....
*132532	-----	" " " Body.....
1038C	5569	" " " Set Screw....
19047	7407	" " " Clamping Washer...
201J	7407	" " " " Screw
132533	7407	" " " Oil Tube.....
132644	20857	Feed (front) Eccentric (adjustable) complete, Nos. 201J, 19047, 51145C, 132531 to 132533 and two 1038C.....
132651	7407	Feed (front) Eccentric Cover.....
50253J	7407	" " " " Screw.....
132712	20858	" " " Lint Cover (spring)
132785	20858	" " " Lubricator with 132537.....
132537	20858	Feed (front) Eccentric Lubricator Oil Wick (braided cotton).....
132649	20858	Feed (front) Lifting Eccentric with two 462C.....
132539	20858	Feed (front) Lifting Eccentric Connection.....
462C	20846	Feed (front) Lifting Eccentric Set Screw
51145C	7407	" " Regulating Screw.....
132844	20859	" " Rock Shaft.....
132845	-----	Feed (front) Rock Shaft complete, Nos. 42021 and 132844.....
42021	20858	Feed (front) Rock Shaft Crank with 157E.
157E	5569	" " " " Clamping Screw.....
132542	20859	Feed (front) Rock Shaft Hinge Pin with 132544.....
132543	20859	Feed (front) Rock Shaft Hinge Pin Bushing.....
132816	20823	Feed (front) Rock Shaft Hinge Pin Bushing Oil Wick (wick).....
1038C	5569	Feed (front) Rock Shaft Hinge Pin Bushing Set Screw.....
132544	20859	Feed (front) Rock Shaft Hinge Pin Oil Wick (braided cotton).....
*132545	-----	Frame.....
132546	20808	" Bottom Cover with 132594.....
132547	20808	" " " Gasket.....
190E	20846	" " " Screw.....
132548	20821	" Oil Cup.....
132819	20855	" Rotary Shaft with 132558 and 132559.....
132820	-----	Frame Rotary Shaft 132819 with 132774, 132790, 132802 and 132806.....
132790	20834	Frame Rotary Shaft Ball Sleeve.....
132774	20817	" " " " Guide.....

PARTS FOR MACHINE No. 81-73

No.	Plate	Name
*132862	-----	Frame Rotary Shaft Bushing (front).....
132863	20817	" " " " 132862 with 132835, 132864 and two 132715....
132864	20823	Frame Rotary Shaft Bushing (front) Oil Pad (braided cotton).....
132715	20817	Frame Rotary Shaft Bushing (front) Oil Pad Retainer.....
132817	20823	Frame Rotary Shaft Bushing (front) Oil Wick (wick).....
51332C	20821	Frame Rotary Shaft Bushing (front) Set Screw.....
132769	20817	Frame Rotary Shaft Crank with 1036C, 1375C and 132773.....
132770	20817	Frame Rotary Shaft Crank Ball Sleeve....
132771	20817	" " " " " Bushing.....
1664E	20817	Frame Rotary Shaft Crank Ball Sleeve Bushing Nut.....
132772	20817	Frame Rotary Shaft Crank Ball Sleeve Bushing Nut Washer.....
132773	20846	Frame Rotary Shaft Crank Ball Sleeve Bushing Position Pin.....
132774	20817	Frame Rotary Shaft Crank Ball Sleeve Guide.....
1375C	20817	Frame Rotary Shaft Crank Position Screw.
1038C	5569	" " " " Set Screw.....
132775	-----	Frame Rotary Shaft Crank complete, Nos. 1664E and 132769 to 132772.....
132835	20817	Frame Rotary Shaft Crank Oil Sling Cover
*132865	20855	" " " Flanged Bushing (back)
132866	-----	" " " " " 132865 with 132892, 132867, 132868 and two 132603.....
132867	20823	Frame Rotary Shaft Flanged Bushing (back) Oil Pad (large).....
132868	20823	Frame Rotary Shaft Flanged Bushing (back) Oil Pad (small) braided cotton.....
132603	20834	Frame Rotary Shaft Flanged Bushing (back) Oil Pad Retainer.....
132817	20823	Frame Rotary Shaft Flanged Bushing (back) Oil Wick (wick).....
51332C	20821	Frame Rotary Shaft Flanged Bushing (back) Set Screw.....
132558	20823	Frame Rotary Shaft Oil Pad (braided cotton).....
132559	20823	Frame Rotary Shaft Oil Pad Retainer.....
*132692	20834	" " " " Sling Cover.....
132560	20855	" Side Cover (left) with 132701.....
132701	20821	" " " " Handle.....
330W	20821	" " " " Screw.....

PARTS FOR MACHINE No. 81-73

No.	Plate	Name
42028	20855	Frame Side Cover (right) hinged.....
42101	20821	" " " " Lock Spring....
330W	20821	" " " " Screw.....
132846	20874	" Top Cover.....
132847	-----	" " " " 132846 with 132782 to 132784 and two 197J.....
132650	7409	Frame Top Cover Extension.....
42102	7409	" " " " Holder.....
132600	-----	" " " " 42102 with 42101, 132650, 132651 and two each 178J and 50253J.....
283W	7409	Frame Top Cover Extension Holder Thumb Screw.....
19044	7407	Frame Top Cover Extension Holder Thumb Screw Washer.....
176J	20846	Frame Top Cover Extension Screw.....
132782	20821	" " " " Oil Reservoir Cover....
197J	20846	" " " " Screw.....
132783	20821	" " " " Tube.....
132784	20821	" " " " Wick.....
583F	20846	" " " " Screw (large).....
742F	20846	" " " " (small).....
42305	20818	Knife (movable).....
Note: Two No. 42305 are sent with this machine.		
42306	20818	Knife (movable) Gib.....
42307	20818	" " " " Holder.....
42308	-----	" " " " 42307 with 133F, 42040 and 42306.....
42038	7409	Knife (movable) Holder Guide with 336F..
42039	7409	" " " " " Plate.....
621E	7409	" " " " " Screw.
336F	7409	" " " " " Set Screw..
133F	7409	" " " " " Screw.....
42040	7409	" " " " " Extension Pin.....
42041	7409	Knife (movable) Holder Spring.....
132821	20834	" " " " Lever with 175E.....
132563	20834	" " " " " Connection with two 1057C.....
132820	-----	Knife (movable) Lever Connection 132563 with 132649.....
1057C	7407	Knife (movable) Lever Connection Cap Screw.....
132565	20834	Knife (movable) Lever Connection Hinge Stud.....
175E	20846	Knife (movable) Lever Connection Hinge Stud Set Screw.....
42045	20834	Knife (movable) Lever Hinge Stud.....
1229C	20846	" " " " " Set Screw.....

PARTS FOR MACHINE No. 81-73

No.	Plate	Name
42309	20818	Knife (stationary) with 42049.....
Note: Two No. 42309 are sent with this machine....		
42310	20818	Knife (stationary) Clamping Stud.....
1534D	20818	" " " " " Thumb Nut.....
132767	20818	Knife (stationary) Holder.....
1376C	20818	" " " " " Regulating Thumb Screw.....
1101C	20807	Knife (stationary) Holder Screw.....
440C	7409	" " " " " Stop Screw....
1547J	7409	" " " " " " Nut
42049	20818	" " " " " Stud.....
42050	20861	Looper (left hand).....
50117C	20846	" " " " " Clamping Screw.....
132795	20861	" " " " " Lever with 50117C....
132796	20861	" " " " " Connecting Link
132797	20861	" " " " " " "
		Hinge Pin.....
51459E	20861	Looper (left hand) Lever Connecting Link Screw.....
1735J	20861	Looper (left hand) Lever Connecting Link Screw Nut.....
132798	20861	Looper (left hand) Lever Hinge Stud with 132552.....
132552	20861	Looper (left hand) Lever Hinge Stud Oil Pad (braided cotton).....
132816	20823	Looper (left hand) Lever Hinge Stud Oil Wick (wick).....
1036C	5569	Looper (left hand) Lever Hinge Stud Set Screw.....
132630	20862	Looper (right hand).....
132799	20862	" " " " " and Spreader Lever with 233E, 241E and 140123C.....
132800	-----	Looper (right hand) and Spreader Lever 132799 with 132699.....
132801	-----	Looper (right hand) and Spreader Lever 132800 with 42242, 132795, 132798 and two each 1735J, 51459E, 132796 and 132797.....
132802	20817	Looper (right hand) and Spreader Lever Ball Stud.....
140123C	20846	Looper (right hand) and Spreader Lever Ball Stud Set Screw.....
132777	20817	Looper (right hand) and Spreader Lever Connection with four 896C.....
132779	-----	Looper (right hand) and Spreader Lever Connection 132777 with 132774, 132775 and 132802.....
896C	20817	Looper (right hand) and Spreader Lever Connection Cap (lower) Screw.....

PARTS FOR MACHINE No. 81-73

No.	Plate	Name
59534	20865	Tension (looper, left hand) Spring.....
59537	20865	" " " " Bush-
		ing (large).....
59538	20865	Tension (looper, left hand) Spring Bush-
		ing (small).....
132599	20865	Tension (looper, left hand) Thread Guide
2102	20865	" (looper, right hand) Disc.....
51570C	20865	" " " " Regulating
		Thumb Nut.....
50148C	20865	Tension (looper, right hand) Screw Stud.
132871	-----	" " " " " "
		50148C with 51570C.....
59535	20865	Tension (looper, right hand) Spring.....
59537	20865	" " " " " Bush-
		ing (large).....
59538	20865	Tension (looper, right hand) Spring
		Bushing (small).....
57076	20866	Tension (looper, right hand) Thread
		Guide.....
2102	20865	Tension (needle thread) Disc.....
51570C	20865	" " " " Regulating Thumb
		Nut.....
50261C	20865	Tension (needle thread) Screw Stud.....
132360	-----	" " " " "50261C
		with 51570C.....
59535	20865	Tension (needle thread) Spring.....
59537	20865	" " " " " Bushing
		(large).....
59538	20865	Tension (needle thread) Spring Bushing
		(small).....
42242	20866	Thread (looper, left hand) Eyelet.....
233E	20816	" " " " " Screw..
42122	20844	" " " " " Nipper Spring
		(lower).....
42123	20844	Thread (looper, left hand) Nipper Spring
		(upper).....
176J	20846	Thread (looper, left hand) Nipper Spring
		Screw.....
132591	20844	Thread (looper, left hand) Pull-off.....
42244	20844	" " " " " Eyelet
207J	20846	" " " " " " "
		Screw.....
42084	20865	Thread (looper, left hand) Tube.....
462C	20846	" " " " " " Set Screw
132872	20844	" (looper, right hand) Controller..
42126	20844	" " " " " Pull-off....
132864	20844	" " " " " Staple.....
176J	20846	" " " " " " Screw.
7071	20821	" " " " " " "
		Washer.....

PARTS FOR MACHINE No. 81-73

No.	Plate	Name
132812	20865	Thread (looper, right hand) Take-up.....
185J	20865	" " " " " Screw
132873	20865	" (needle) Eyelet with 52130.....
52130	20865	" " " " Bushing.....
223J	20846	" " " " " Screw.....
132914	20866	" " " " " Take-up.....
197J	20846	" " " " " Screw.....
132875	20844	" " " " " Staple and Thread
		Guide with two 52130.....
52130	20865	Thread (needle) Take-up Staple and
		Thread Guide Bushing.....
132920	20868	Throat Plate, for 1/8 in. to 3/16 in.
		bight, for 132836 and 132843.....
132689	20869	Throat Plate, for 3/16 in. to 1/4 in.
		bight, for 132836 and 132843.....
742F	20846	Throat Plate Screw.....
*15404	-----	Trade Mark.....
15405	-----	" " " Rivet.....

PARTS REQUIRED FOR TWO-THREAD STITCH

No.	Plate	Name
228J	20846	Needle Bar Thread Retainer Bracket Screw
132631	20862	Spreader, in place of Looper (right
		hand) 132630.....
42082	20866	Tension (needle thread) Thread Guide, in
		place of 132875.....
42096	20866	Thread (needle) Eyelet, in place of
		132873.....
132883	20866	Thread (needle) Take-up, in place of
		132914.....

FITTINGS

FOR KNIT GOODS

FOR 1/8 IN. TO 3/16 IN. BIGHT

No.	Plate	Name
132836	20868	Feed (back) Dog (16 teeth to the inch)
		for 132689 and 132920.....
132843	20868	Feed (front) Dog (16 teeth to the inch)
		for 132689 and 132920.....
132879	-----	Presser Foot Body with 735C.....
132680	20868	" " " Chaining-off Finger.....
233J	20816	" " " " " Screw...

FITTINGS

No.	Plate	Name
132609	20868	Presser Foot Chaining-off Plate.....
132610	20868	" " " Collar with 240C.....
132611	20868	Presser Foot Chaining-off Plate Collar Guide Pin.....
735C	20846	Presser Foot Chaining-off Plate Collar Guide Pin Set Screw.....
240C	20846	Presser Foot Chaining-off Plate Collar Set Screw.....
14058	20816	Presser Foot Chaining-off Plate Spring..
132681	20868	Presser Foot (solid) complete, for knit goods, Nos. 233J, 14058, 132609 to 132611, 132679 and 132680.....
132920	20868	Throat Plate, for 132836 and 132843.....

FOR KNIT GOODS

FOR 3/16 IN. TO 1/4 IN. BIGHT

NOTE: THESE FITTINGS ARE THE SAME AS 1/8 IN. TO 3/16 IN.
BIGHT WITH THE FOLLOWING EXCEPTION:

No.	Plate	Name
132669	20868	Throat Plate for 132836 and 132843, in place of 132920.....

FOR RAYON

FOR 1/16 IN. BIGHT

No.	Plate	Name
132848	20870	Feed (back) Dog (22 teeth to the inch) for 132690 and 132850.....
132849	20870	Feed (front) Dog (22 teeth to the inch) for 132690 and 132850.....
132876	20870	Presser Foot Chaining-off Finger.....
233J	20816	" " " Screw..
132609	20868	" " " Plate.....
132610	20868	" " " Collar with 240C.....
132611	20868	Presser Foot Chaining-off Plate Collar Guide Pin.....
735C	20846	Presser Foot Chaining-off Plate Collar Guide Pin Set Screw.....
240C	20846	Presser Foot Chaining-off Plate Collar Set Screw.....

FITTINGS FOR RAYON

No.	Plate	Name
14058	20816	Presser Foot Chaining-off Plate Spring..
42461	20856	" " Hinge Pin.....
132856	-----	" " Plate.....
132685	-----	" " Shank with 735C.....
132877	20870	Presser Foot (hinged) complete, for rayon Nos. 233J, 14058, 42461, 132609 to 132611, 132685, 132856 and 132876.....
132850	20870	Throat Plate, for 132848 and 132849.....

FOR RAYON

FOR 3/32 IN. TO 5/32 IN. BIGHT

NOTE: THESE FITTINGS ARE THE SAME AS 1/16 IN. BIGHT
WITH THE FOLLOWING EXCEPTION:

No.	Plate	Name
132690	20871	Throat Plate, for 132848 and 132849, in place of 132850.....

FITTINGS FOR FOLDING THE EDGE ON THE
TOP OF WASH CLOTHS

No.	Plate	Name
132892	20872	Feed (back) Dog (16 teeth to the inch) for 132899.....
132893	20872	Feed (front) Dog (16 teeth to the inch) for 132899.....
132894	20872	Presser Foot Chaining-off Plate.....
132610	20868	" " " Collar with 240C.....
132611	20868	Presser Foot Chaining-off Plate Collar Guide Pin.....
735C	20846	Presser Foot Chaining-off Plate Collar Guide Pin Set Screw.....
240C	20846	Presser Foot Chaining-off Plate Collar Set Screw.....
14058	20816	Presser Foot Chaining-off Plate Spring..
132895	20872	" " Edge Folder.....
132896	20872	" " " Plate.....
233J	20816	" " " Screw.....
42461	20856	" " Hinge Pin.....
132897	-----	" " Plate.....
132685	-----	" " Shank with 735C.....
132898	20872	Presser Foot (spring hinged) complete, Nos. 233J, 14058, 42461, 132610, 132611, 132685 and 132894 to 132897.....
132899	20872	Throat Plate, for 132892 and 132893.....

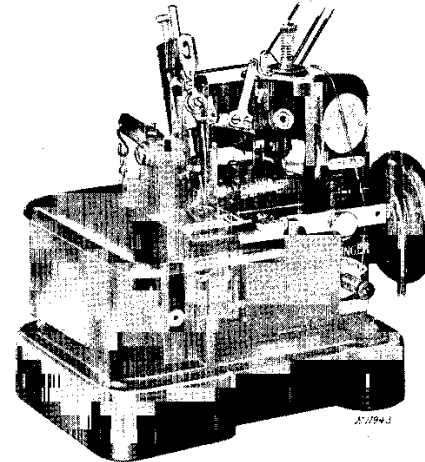
**FITTINGS FOR INSERTING TAPE AND FOLDING
THE EDGE ON THE TOP OF SEAT COVERS**

No.	Plate	Name
132892	20872	Feed (back) Dog (16 teeth to the inch) for 132899.....
132893	20872	Feed (front) Dog (16 teeth to the inch) for 132899.....
132900	-----	Presser Foot Body with 735C.....
132609	20868	" " Chaining-off Plate.....
132610	20868	" " " " Collar with 240C.....
132611	20868	Presser Foot Chaining-off Plate Collar Guide Pin.....
735C	20846	Presser Foot Chaining-off Plate Collar Guide Pin Set Screw.....
240C	20846	Presser Foot Chaining-off Plate Collar Set Screw.....
14058	20816	Presser Foot Chaining-off Plate Spring.
132895	20872	" " Edge Folder.....
132901	20873	" " Tape Guide.....
233J	20816	" " " " Screw.....
132902	20873	Presser Foot (solid) complete, Nos. 233J 14058, 132609 to 132611, 132895, 132900 and 132901.....
42137	20873	Tape Guide.....
132899	20872	Throat Plate, for 132892 and 132893.....

**Genuine Singer Needles should be used
in Singer Machines.
These Needles and their Containers
are marked with the
Company's Trade Mark "SIMANCO." 1**

**Needles in Containers marked
"For Singer Machines"
are not Singer made needles. 2**

**LIST OF PARTS COMPLETE
FOR**



MACHINE No. 81-76

For Trimming, Overedging and Blind Stitch Hemming or
Welting in Knit Underwear. Three-thread stitch. Foot lifter.
Gathering feed. Needle bar stroke 7/8 inch. Will stitch ma-
terial up to 3/16 inch in thickness. Speed 4500 R. P. M. for
long runs.

No.	Plate	Name
*132522	-----	Arm with 15404, 42253, 132580 and two each 462C, 624C, 15405 and 132589.....
4389	20821	Arm Dowel Pin.....
68350	20821	" Oil Cup.....
949E	20846	" Screw.....
132632	20855	Balance Wheel, 1 7/8 in. pulley with 446C and 1285C.....
1285C	20807	Balance Wheel Position Screw.....
446C	7409	" " Set Screw.....
132654	20855	Chip Guard.....
132524	20808	Cloth Plate with 132525.....
132601	20808	" " Extension (lower).....
233E	20816	" " " " Screw.....
42108	20821	" " " " (upper).....
233E	20816	" " " " Screw.....

PARTS FOR MACHINE No. 81-76

No.	Plate	Name
*132525	-----	Cloth Plate Hinge Bracket.....
132526	20821	" " " Stud.....
50150C	20821	" " " Set Screw.....
42005	20821	" " Lock Spring.....
236C	20821	" " " Screw.....
132527	-----	Cloth Plate complete, Nos. 42005, 42108, 132524, 132601, two 236C and five 233E.....
42147	7406	Feed (back) Bar.....
61C	7406	" " " Hinge Screw.....
42148	7406	" " Connecting Link.....
1132C	7406	" " " Hinge Screw.
42149	20816	" " Dog, 3 teeth (16 teeth to the inch) for knit goods, for 42452
193E	20856	Feed (back) Dog Screw.....
42150	7406	" " Regulator.....
1132C	7406	" " " Hinge Screw.....
190J	20846	" " " Set Screw.....
1444C	7406	" " " Thumb Screw.....
42151	7406	" (front) Bar with 1253C.....
132624	-----	" " " 42151 with 61C, 42147, 42148, 42150, 132528, 132539, 132541 and two 1132C.....
132528	7406	Feed (front) Bar Hinge Pin.....
1253C	20846	" " " " Set Screw...
132529	7407	" " Connecting Rod with 171C, 1695J and two 1057C.....
132619	-----	Feed (front) Connecting Rod 132529 with 132534.....
1057C	7407	Feed (front) Connecting Rod Cap Screw..
51292C	7407	" " " " Hinge Screw
171C	7407	" " " " " Clamping Screw.....
1695J	7407	Feed (front) Connecting Rod Hinge Screw Clamping Screw Nut.....
1520J	5569	Feed (front) Connecting Rod Hinge Screw Nut.....
42182	20816	Feed (front) Dog, 17 teeth (16 teeth to the inch) for knit goods, for 42452.
190E	20846	Feed (front) Dog Screw.....
*132531	-----	" " Eccentric.....
*132702	-----	" " " Body.....
1036C	5569	" " " Set Screw..
19047	7407	" " " Clamping Washer.
201J	7407	" " " " " Screw.....
132533	7407	Feed (front) Eccentric Oil Tube.....
132534	7407	Feed (front) Eccentric complete, Nos. 201J, 19047, 51145C, 132531, 132533, 132702 and two 1036C.....

PARTS FOR MACHINE No. 81-76

No.	Plate	Name
132651	7407	Feed (front) Eccentric Cover.....
50253J	7407	" " " " Screw.....
13271E	20858	" " " Lint Cover (spring).....
132785	20858	Feed (front) Eccentric Lubricator with 132537.....
132537	20858	Feed (front) Eccentric Lubricator Oil Wick (braided cotton).....
132649	20858	Feed (front) Lifting Eccentric with two 462C.....
132539	20858	Feed (front) Lifting Eccentric Connec- tion.....
462C	20846	Feed (front) Lifting Eccentric Set Screw.....
51145C	7407	Feed (front) Regulating Screw.....
132540	7406	" " Rock Shaft.....
132541	-----	Feed (front) Rock Shaft complete, Nos. 1444C, 42021 and 132540.....
42021	20858	Feed (front) Rock Shaft Crank with 157E
157E	5569	" " " " Clamping Screw.....
132542	20859	Feed (front) Rock Shaft Hinge Pin with 132544.....
132543	20859	Feed (front) Rock Shaft Hinge Pin Bush- ing.....
132816	20823	Feed (front) Rock Shaft Hinge Pin Bush- ing Oil Wick (wick).....
1036C	5569	Feed (front) Rock Shaft Hinge Pin Bush- ing Set Screw.....
132544	20859	Feed (front) Rock Shaft Hinge Pin Oil Wick (braided cotton).....
*132545	-----	Frame.....
132546	20808	" Bottom Cover with 132594.....
132547	20808	" " " Gasket.....
190E	20846	" " " Screw.....
132548	20821	" Oil Cup.....
132819	20855	" Rotary Shaft with 132558 and 132559.....
132820	-----	Frame Rotary Shaft 132819 with 132774, 132790, 132802 and 132806.....
132790	20834	Frame Rotary Shaft Ball Sleeve.....
132774	20817	" " " Guide...
*132862	-----	" " " Bushing (front)....
132863	20817	" " " " 132862 with 132835, 132864 and two 132715..
132864	20823	Frame Rotary Shaft Bushing (front) Oil Pad (braided cotton).....
132715	20817	Frame Rotary Shaft Bushing (front) Oil Pad Retainer.....

No.	Plate	Name
132817	20823	Frame Rotary Shaft Bushing (front) Oil Wick (wick).....
51332C	20821	Frame Rotary Shaft Bushing (front) Set Screw.....
132769	20817	Frame Rotary Shaft Crank with 1036C, 1375C and 132773.....
132770	20817	Frame Rotary Shaft Crank Ball Sleeve.....
132771	20817	" " " " " "
		Bushing.....
1664E	20817	Frame Rotary Shaft Crank Ball Sleeve Bushing Nut.....
132772	20817	Frame Rotary Shaft Crank Ball Sleeve Bushing Nut Washer.....
132773	20846	Frame Rotary Shaft Crank Ball Sleeve Bushing Position Pin.....
132774	20817	Frame Rotary Shaft Crank Ball Sleeve Guide.....
1375C	20817	Frame Rotary Shaft Crank Position Screw
1036C	5569	" " " " Set Screw.....
132775	-----	Frame Rotary Shaft Crank complete, Nos. 1664E and 132769 to 132772.....
132835	20817	Frame Rotary Shaft Crank Oil Sling Cover.....
132865	20855	Frame Rotary Shaft Flanged Bushing (back).....
132866	-----	Frame Rotary Shaft Flanged Bushing (back) 132865 with 132692, 132867, 132868 and two 132603.....
132867	20823	Frame Rotary Shaft Flanged Bushing (back) Oil Pad (large).....
132868	20823	Frame Rotary Shaft Flanged Bushing (back) Oil Pad (small) braided cotton.....
132603	20834	Frame Rotary Shaft Flanged Bushing (back) Oil Pad Retainer.....
132817	20823	Frame Rotary Shaft Flanged Bushing (back) Oil Wick (wick).....
51332C	20821	Frame Rotary Shaft Flanged Bushing (back) Set Screw.....
132558	20823	Frame Rotary Shaft Oil Pad (braided cotton).....
132559	20823	Frame Rotary Shaft Oil Pad Retainer....
132692	20834	" " " " Sling Cover.....
132560	20855	" Side Cover (left) with 132701....
132701	20821	" " " " Handle.....
330W	20821	" " " " Screw.....
42028	20855	" " " (right) hinged.....
42101	20821	" " " " Lock Spring...
330W	20821	" " " " Screw.....
132780	20808	" Top Cover.....

No.	Plate	Name
132781	-----	Frame Top Cover 132780 with 132782 to 132784 and two 197J.....
132650	7409	Frame Top Cover Extension.....
42102	7409	" " " " Holder.....
132600	-----	" " " " 42102 with 42101, 132650, 132651 and two each 176J and 50253J.....
283W	7409	Frame Top Cover Extension Holder Thumb Screw.....
19044	7407	Frame Top Cover Extension Holder Thumb Screw Washer.....
176J	20846	Frame Top Cover Extension Screw.....
132782	20821	" " " Oil Reservoir Cover....
197J	20846	" " " " " " Screw
132783	20821	" " " " Tube.....
132784	20821	" " " " Wick.....
583F	20846	" " " Screw (large).....
742F	20846	" " " " (small).....
42213	7409	Knife (movable).....
Note: Two No. 42213 are sent with this machine.		
42214	7409	Knife (movable) Gib.....
42035	7409	" " " Holder.....
132627	-----	" " " 42035 with 133F 42037, 42040, 42214 and two 404D....
42037	7409	Knife (movable) Holder Cap.....
404D	7409	" " " " Screw.....
42038	7409	" " " Guide with 336F....
42039	7409	" " " " Plate.....
621E	7409	" " " " Screw....
336F	7409	" " " " Set Screw..
133F	7409	" " " Screw.....
42040	7409	" " " " Extension Pin.....
42041	7409	Knife (movable) Holder Spring.....
132821	20834	" " " Lever with 175E.....
132563	20834	" " " Connection with two 1057C.....
132620	-----	Knife (movable) Lever Connection 132563 with 132649.....
1057C	7407	Knife (movable) Lever Connection Cap Screw.....
132565	20834	Knife (movable) Lever Connection Hinge Stud.....
175E	20846	Knife (movable) Lever Connection Hinge Stud Set Screw.....
42045	20834	Knife (movable) Lever Hinge Stud.....
1229C	20846	" " " " " Set Screw.....
42046	20860	Knife (stationary) with 42049.....
Note: Two No. 42046 are sent with this machine.		

No.	Plate	Name
42048	20860	Knife (stationary) Clamping Stud.....
1534D	20818	" " " " Thumb Nut.....
132766	20860	Knife (stationary) Holder.....
1376C	20818	" " " " Regulating Thumb Screw.....
1101C	20807	Knife (stationary) Holder Screw.....
440C	7409	" " " " Stop Screw....
1547J	7409	" " " " Nut.
42049	20818	" " " " Stud.....
42050	20861	Looper (left hand).....
50117C	20846	" " " " Clamping Screw.....
132795	20861	" " " " Lever with 50117C....
132796	20861	" " " " Connecting Link
132797	20861	" " " " " " "
51459E	20861	Hinge Pin.....
1735J	20861	Looper (left hand) Lever Connecting Link Screw.....
132798	20861	Looper (left hand) Lever Connecting Link Screw Nut.....
132552	20861	Looper (left hand) Lever Hinge Stud with 132552.....
132816	20823	Looper (left hand) Lever Hinge Stud Oil Pad (braided cotton).....
1036C	5569	Looper (left hand) Lever Hinge Stud Oil Wick (wick).....
132630	20862	Looper (left hand) Lever Hinge Stud Set Screw.....
132799	20862	Looper (right hand).....
132800	-----	Looper (right hand) and Spreader Lever with 233E, 241E and 140123C.....
132801	-----	Looper (right hand) and Spreader Lever 132799 with 132699.....
132802	20817	Looper (right hand) and Spreader Lever 132800 with 42242, 132795, 132798 and two each 1735J, 51459E, 132796 and 132797.....
140123C	20846	Looper (right hand) and Spreader Lever Ball Stud.....
132777	20817	Looper (right hand) and Spreader Lever Ball Stud Set Screw.....
132779	-----	Looper (right hand) and Spreader Lever Connection with four 896C.....
896C	20817	Looper (right hand) and Spreader Lever Connection 132777 with 132774, 132775 and 132802.....
896C	20817	Looper (right hand) and Spreader Lever Connection Cap (lower) Screw.....
896C	20817	Looper (right hand) and Spreader Lever Connection Cap (upper) Screw.....

No.	Plate	Name
132699	20862	Looper (right hand) and Spreader Lever Hinge Pin with 125056.....
132543	20859	Looper (right hand) and Spreader Lever Hinge Pin Bushing.....
132816	20823	Looper (right hand) and Spreader Lever Hinge Pin Bushing Oil Wick (wick)...
1036C	5569	Looper (right hand) and Spreader Lever Hinge Pin Bushing Set Screw.....
125056	20862	Looper (right hand) and Spreader Lever Hinge Pin Oil Wick (braided cotton).
1036C	5569	Looper (right hand) and Spreader Lever Hinge Pin Set Screw.....
241E	20846	Looper (right hand) and Spreader Lever Oil Plug Screw.....
197J	20846	Looper (right hand) Screw.....
42054	20863	Needle Bar.....
42253	20863	" " Bushing (lower).....
132580	20863	" " " " (upper).....
132581	20863	" " " " Oil Pad (braided cotton).....
462C	20846	Needle Bar Bushing Set Screw.....
132598	20863	" " Connecting Bracket with 187E and 223F.....
187E	20846	Needle Bar Connecting Bracket Clamping Screw.....
132582	20863	Needle Bar Connecting Link.....
132583	20863	" " " " Hinge Pin with 132584.....
132584	20863	Needle Bar Connecting Link Hinge Pin Oil Pad (wick).....
223F	20846	Needle Bar Connecting Link Hinge Pin Set Screw, for 132598.....
620C	20846	Needle Bar Connecting Link Hinge Pin Set Screw, for 132860.....
132806	20864	Needle Bar Connecting Rod with four 896C
896C	20817	" " " " Cap (lower) Screw.....
896C	20817	Needle Bar Connecting Rod Cap (upper) Screw.....
132879	20864	Needle Bar Crank (back) with 132590 and two 1259C.....
132802	20817	Needle Bar Crank (back) Ball Stud.....
1259C	20846	" " " " " " Set Screw.....
132589	20864	Needle Bar Crank (back) Bushing.....
624C	20846	" " " " " " Set Screw
132590	20864	" " " " " Oil Pad (wick)..
1259C	20846	" " " " " Set Screw.....
132880	20864	" " " " (front) with 620C, 50200C and 140123C.....

No.	Plate	Name
132882	-----	Needle Bar Crank (front) 132880 with 132582, 132598 and two 132583.....
140123C	20846	Needle Bar Crank (front) Position Screw.
50200C	20846	" " " " Set Screw.....
42115	20863	" " " " Thread Retainer Bracket.....
228J	20846	" " " " " " Screw.
42483	20863	" " " " " " Disc.....
93C	20846	" " " " " " Screw.....
10107	20863	" " " " " " Spring.....
1728C	20846	" " " " " " Clamping Nut.....
42066	20863	" " " " " " Guard.....
171F	7407	" " " " " " Screw.....
42183	-----	Presser Foot Body.....
42184	20816	" " " " " " Chaining-off Finger.....
233J	20816	" " " " " " Screw.....
9320	20816	" " " " " " Hinge Pin.....
42159	-----	" " " " " " Plate.....
14058	20816	" " " " " " Spring.....
42160	20816	" " " " " " Adjusting Pin.....
464C	20816	" " " " " " Set Screw.....
42185	20816	Presser Foot (spring hinged) complete, Nos. 233J, 464C, 9320, 14058, 42159, 42160, 42183 and 42184.....
1324C	20824	Presser Foot Screw.....
39541	20824	" " " " " " Washer.....
42069	20839	" " " " " " Lever.....
42376	-----	" " " " " " 42069 with 42045.....
42045	20834	" " " " " " Hinge Stud.....
1120C	20846	" " " " " " Set Screw.....
42070	20839	" " " " " " Lifter.....
85D	20839	" " " " " " Hinge Screw.....
1377C	20807	" " " " " " Screw Stud (eccentric)....
1547J	7409	" " " " " " Nut.....
42071	20839	" " " " " " Spring.....
1378D	20839	Pressure Regulating Thumb Screw.....
2102	20865	Tension (looper, left hand) Disc.....
51570C	20865	" " " " " " Regulating Thumb Nut.....
50326C	20865	Tension (looper, left hand) Screw Stud..
59539	-----	" " " " " " 50326C with 51570C.....
59534	20865	Tension (looper, left hand) Spring.....
59537	20865	" " " " " " Bushing (large).....
59538	20865	Tension (looper, left hand) Spring Bushing (small).....
132599	20865	Tension (looper, left hand) Thread Guide
2102	20865	" " " " " " (looper, right hand) Disc.....
51570C	20865	" " " " " " Regulating Thumb Nut.....

No.	Plate	Name
50148C	20865	Tension (looper, right hand) Screw Stud.
132871	-----	" " " " " " 50148C with 51570C.....
59535	20865	Tension (looper, right hand) Spring.....
59537	20865	" " " " " " Bushing (large).....
59538	20865	Tension (looper, right hand) Spring Bushing (small).....
57076	20866	Tension (looper, right hand) Thread Guide.....
2102	20865	Tension (needle thread) Disc.....
51570C	20865	" " " " " " Regulating Thumb Nut.....
50261C	20865	Tension (needle thread) Screw Stud.....
132360	-----	" " " " " " 50261C with 51570C.....
59535	20865	Tension (needle thread) Spring.....
59537	20865	" " " " " " Bushing (large).....
59538	20865	Tension (needle thread) Spring Bushing (small).....
42082	20866	Tension (needle thread) Thread Guide.....
42242	20866	Thread (looper, left hand) Eyelet.....
233E	20816	" " " " " " Screw.....
42122	20844	" " " " " " Nipper Spring (lower).....
42123	20844	Thread (looper, left hand) Nipper Spring (upper).....
176J	20846	Thread (looper, left hand) Nipper Spring Screw.....
132591	20844	Thread (looper, left hand) Pull-off.....
42244	20844	" " " " " " Eyelet.....
207J	20846	" " " " " " Screw.....
42084	20865	Thread (looper, left hand) Tube.....
462C	20846	" " " " " " Set Screw
132872	20844	" " (looper, right hand) Controller..
42126	20844	" " " " " " Pull-off....
132864	20844	" " " " " " Staple.....
176J	20846	" " " " " " Screw.....
7071	20821	" " " " " " Washer.....
132812	20865	Thread (looper, right hand) Take-up....
185J	20865	" " " " " " Screw.....
42096	20866	" " (needle) Eyelet.....
217J	20846	" " " " " " Screw.....
42128	20866	" " " " " " Take-up.....
197J	20846	" " " " " " Screw.....
42452	20816	Throat Plate, for knit goods, for 42149 and 42182.....

PARTS FOR MACHINE No. 81-76

No.	Plate	Name
742F	20846	Throat Plate Screw.....
*15404	-----	Trade Mark.....
15405	-----	" " Rivet.....
42473	20825	Welt Guide.....
42475	20825	" " Hinge (female half).....
42476	20825	" " " (male half).....
42474	20825	" " " Pin.....
42477	20825	" " " Rivet.....
132710	20825	" " Holder.....
*132758	-----	" " 132710 with 190J, 1117J, 1209C and 22436.....
1209C	20825	Welt Guide Holder Screw.....
22436	20825	" " " Washer.....
1117J	20825	" " Regulating Thumb Screw.....
190J	20846	" " Screw.....
42478	20825	" " Spring.....
132869	-----	" " 42478 with 42475 and two 42477.....
42188	20825	Welt Guide (hinged) complete, Nos. 42473, 42474, 42476, 132869 and two 42477....

Genuine Singer Needles should be used
in Singer Machines.
These Needles and their Containers
are marked with the
Company's Trade Mark "SIMANCO." 1

Needles in Containers marked
"For Singer Machines"
are not Singer made needles. 2

ACCESSORIES

No.	Plate	Name
1408J	20826	Machine Base Thumb Screw, for 1 5/8 in. Tables and Individual Stands, for use when machine is mounted on top of table.....
474J	20826	Machine Base Thumb Screw, for use when machine is mounted 1 1/2 in. lower than standard.....
14083	20807	Machine Base Thumb Screw Spring, for Thumb Screw No. 1408, when machine is mounted on Individual Stand.....
27498	20826	Machine Base Thumb Screw Spring, for Thumb Screw No. 1408 on 1 5/8 in. Tables and Thumb Screw No. 474, when machine is mounted 1 1/2 in. lower than standard.....
9842	7419	Machine Base Thumb Screw Spring Washer..
132802	20807	" " " Washer.....
120344	5566	Oiler (copper plated) with 120345.....
120345	5566	" Spout, 4 1/2 in. long.....
120440	5566	Screw Driver (machine).....
42090	5566	Threading Wire.....
120341	5566	Tweezers (curved).....
42089	5566	Wrench for 1324 and 1728.....
8908	5566	" " 1520.....
4822	*5566	" " 1547.....

BENCH STANDS

BENCH STAND
FOR MACHINE BASE No. 132592

WHEN MACHINE IS MOUNTED ON TOP OF TABLE

No.	Plate	Name
79768	-----	Bench Stand with 27998, two each 28291, 46548 and wood screws 1 1/2 in. No. 14 F.H.....
28291	20807	Cover Hinge with two each wood screws 1/2 in. No. 5 F.H. and 5/8 in. No. 5 F.H.....
27998	20807	Cover Hook and Eye (brass) with wood screw 1/2 in. No. 5 F.H.....
46548	20807	Cover Rest (felt).....

**BENCH STAND
FOR MACHINE BASE No. 132656**

WHEN MACHINE IS MOUNTED 1/2 IN. LOWER THAN STANDARD

No.	Plate	Name
79790	-----	Bench Stand with 27998, 60820, two each 28291, 46548, 150244 and three each wood screws 1 1/4 in. No. 12 F.H. and 1 1/2 in. No. 14 F.H.....
60820	-----	Cover Chain, 9 1/4 in. long, with two 56865.....
56865	20807	Cover Chain Hook.....
150244	20826	" " Screw Eye.....
28291	20807	" Hinge with two each wood screws 1/2 in. No. 5 F.H. and 5/8 in. No. 5 F.H.....
27998	20807	Cover Hook and Eye (brass) with wood screw 1/2 in. No. 5 F.H.....
46548	20807	Cover Rest (felt).....

FOOT LIFTER PARTS

No.	Plate	Name
6439	-----	Chain, 36 in. to 45 in., with 56864 and 56865.....
Note: When ordering No. 6439, state length required.		
4879	5566	Chain Connecting Link.....
56864	5566	" Hook (large).....
56865	20807	" " (small).....
42130	20824	Lifting Lever.....
42131	20824	" " Bracket.....
1229C	20846	" " Screw.....
1301D	20865	" " Hinge Screw.....
42132	20824	" " Spring.....
1148F	20824	" " Stop Screw.....
1547J	7409	" " Nut.....
4881	20808	Treadle.....
4882	5566	" Shaft.....
4883	5566	" Spring.....
4884	20808	" Stand.....
4885	20808	Treadle complete, Nos. 4879, 4881 to 4884 and two wood screws 1 in. No. 16....
42133	-----	Foot Lifter complete, Nos. 1301D, 4885, 6439 42130 to 42132 and two each 1148F, 1229C and 1547J.....

KNEE LIFTER PARTS

No.	Plate	Name
42130	20824	Lifting Lever.....
42131	20824	" " Bracket.....
1229C	20846	" " Screw.....
42142	20808	" " Connecting Rod.....
1301D	20865	" " Hinge Screw.....
42132	20824	" " Spring.....
1148F	20824	" " Stop Screw.....
1547J	7409	" " Nut.....
2763	20808	Rock Shaft.....
12242	20808	" " Hanger with two wood screws 1 in. No. 10.....
2765	20808	Rock Shaft Knee Arm.....
2766	20808	" " " Hub with 356C.....
356C	20807	" " " Set Screw.....
2768	-----	Rock Shaft Knee Arm complete, Nos. 2765 to 2767.....
2767	20808	Rock Shaft Knee Plate with 356C.....
356C	20807	" " " Set Screw.....
6337	20808	" " Lifting Bracket with two 356C.....
7125	20808	" " " Hook.....
356C	20807	" " " Set Screw.....
356C	20807	" " " Set Screw.....
2770	20808	" " Stop Dog with 356C.....
356C	20807	" " " Set Screw.....
42143	20808	Rock Shaft complete, Nos. 2763, 2768, 6337, 7125 and two each 2770 and 12242....
42144	-----	Knee Lifter complete, Nos. 1301D, 42130 to 42132, 42142, 42143 and two each 1148F, 1229C and 1547J.....

KNIFE GRINDER

FOR 81-70 and 81-73 MACHINES

No.	Plate	Name
41326	20847	Emery Wheel.....
1508C	5569	" " Clamping Nut.....
41327	20847	" " Shaft.....
41328	20847	" " Pulley with 1036C.....
1036C	5569	" " Set Screw.....
41513	5569	" " Washer.....
41329	20830	Frame with 1036C.....
878D	5569	" Oil Hole Stop Screw.....
41818	20847	Knife Holder with two 14222.....

KNIFE GRINDER

No.	Plate	Name
150210	-----	Knife Holder 41818 with 970D,41331,41332 and two each 313C,771D,1519J,41333 and 41334.....
41331	20847	Knife Holder Bracket with 157E.....
157E	5569	" " " Clamping Screw.....
42065	5569	" " " Hinge Stud.....
1036C	5569	" " " " " Set Screw
717C	5569	" " " Stop Screw.....
1520J	5569	" " " " " Nut.....
41333	5569	" " " Clamp.....
41334	5569	" " " Spring.....
14222	5569	" " " Steady Pin.....
771D	5569	" " " Thumb Screw.....
970D	5569	" " " Regulating Thumb Screw.....
313C	5569	" " " Screw Center.....
1519J	5569	" " " " " Nut.....
41332	5569	" " " Spring.....
41819	-----	Knife Grinder complete,Nos.717C,1508C,1520J,41326 to 41329,42065,150210, two each 878D,41513 and three wood screws 1 1/4 in. No. 12.....

KNIFE GRINDER

FOR 81-76 MACHINE

No.	Plate	Name
41326	20847	Emery Wheel.....
1508C	5569	" " " Clamping Nut.....
41327	20847	" " " Shaft.....
41328	20847	" " " Pulley with 1036C.....
1036C	5569	" " " " " Set Screw.....
41513	5569	" " " Washer.....
41329	20830	Frame with 1036C.....
878D	5569	" Oil Hole Stop Screw.....
41330	20874	Knife Holder with two 14222.....
150209	-----	" " 41330 with 970D,41331,41332 and two each 313C,771D,1519J,41333 and 41334.....
41331	20847	Knife Holder Bracket with 157E.....
157E	5569	" " " Clamping Screw.....
42065	5569	" " " Hinge Stud.....
1036C	5569	" " " " " Set Screw
717C	5569	" " " Stop Screw.....
1520J	5569	" " " " " Nut.....
41333	5569	" " " Clamp.....
41334	5569	" " " Spring.....

KNIFE GRINDER

No.	Plate	Name
14222	5569	Knife Holder Clamp Steady Pin.....
771D	5569	" " " Thumb Screw.....
970D	5569	" " " Regulating Thumb Screw.....
313C	5569	" " " Screw Center.....
1519J	5569	" " " " " Nut.....
41332	5569	" " " Spring.....
41335	-----	Knife Grinder complete,Nos.717C,1508C,1520J,41326 to 41329,42065,150209, two each 878D,41513 and three wood screws 1 1/4 in. No. 12.....

MACHINE BASES

MACHINE BASE No. 132592

WHEN MACHINE IS MOUNTED ON TOP OF TABLE

FOR USE WITH BENCH STAND NO. 79768

No.	Plate	Name
132647	20808	Machine Base.....
132595	7419	" " Cushion (large) felt.....
42088	7419	" " " (small) felt.....
132618	7419	" " " " " for 474 or 1408.....
935E	7419	Machine Base Cushion (small) Screw.....
66707	-----	" " " " " Washer
132596	7419	" " " (leather).....
132593	7419	" " Oil Drain Strainer.....
54477	7419	" " Screw Stud.....
51576E	7419	" " " " " Nut.....
9842	7419	" " " " " Washer.....
132594	7419	" " " Thumb Screw Bushing.....
132592	-----	Machine Base complete,Nos.132593,132596,132618,132647,three each 9842,51576E 54477 and four each 935E,42088,66707 and 132595.....
132704	-----	Machine Base and Oil Drain Jar complete, Nos. 131268 and 132592.....

MACHINE BASE No. 132656

WHEN MACHINE IS MOUNTED 1/2 IN. LOWER THAN STANDARD
FOR USE WITH BENCH STAND NO. 79790

No.	Plate	Name
132655	20830	Machine Base.....
132595	7419	" " Cushion (large) felt.....
42088	7419	" " " (small) felt.....
132618	7419	" " " " " for 474 or 1408.....
935E	7419	Machine Base Cushion (small) Screw.....
66707	-----	" " " " " Washer
132596	7419	" " " (leather).....
132593	7419	" " Oil Drain Strainer.....
1204E	20824	" " Position Stud.....
131022	20824	" " " " Bushing (rub- ber).....
132594	7419	Machine Base Thumb Screw Bushing.....
132656	-----	Machine Base complete, Nos. 132593, 132596, 132618, 132655, three each 1204E, 131022 and four each 935E, 42088, 66707 and 132595.....
132705	-----	Machine Base and Oil Drain Jar complete, Nos. 132656 and 132697.....

MACHINE BASE OIL DRAIN JARS**MACHINE BASE OIL DRAIN JAR**

(SWINGING TYPE)

OIL DRAIN JAR No. 131268

FOR MACHINE BASE NO. 132592

FOR BENCH STAND NO. 79768

No.	Plate	Name
131185	20828	Jar (glass).....
131191	20828	" Cap.....
131188	20828	" Clamp.....
131217	-----	" " 131188 with 131189.....
131189	20828	" " Lever.....
1247C	20824	" " Hinge Screw.....
131265	20828	Nipple (long).....
131266	20828	" (short).....

MACHINE BASE OIL DRAIN JAR

No.	Plate	Name
131267	20828	Nipple Elbow.....
131268	-----	Machine Base Oil Drain Jar (swinging type) complete, Nos. 131185, 131191, 131217, 131266 and two each 1247C, 131265 and 131267.....

MACHINE BASE OIL DRAIN JAR

(SWINGING TYPE)

OIL DRAIN JAR No. 132697

FOR MACHINE BASE NO. 132656

FOR BENCH STAND NO. 79790

No.	Plate	Name
131185	20828	Jar (glass).....
131191	20828	" Cap.....
131188	20828	" Clamp.....
131217	-----	" " 131188 with 131189.....
131189	20828	" " Lever.....
1247C	20824	" " Hinge Screw.....
131265	20828	Nipple (long).....
131266	20828	" (short).....
131267	20828	" Elbow.....
132697	-----	Machine Base Oil Drain Jar (swinging type) complete, Nos. 131185, 131191, 131217, 131265 and two each 1247C, 131266 and 131267.....

THREAD UNWINDER

FOR THREE SPOOLS

No.	Plate	Name
225259	20778	Spool Rest (for one spool) with 201018C.
225257	20778	" " (for two spools) with 201018C
150203	20778	" " Cushion (felt).....
225388	20778	" " Rod.....
200383C	20807	" " Set Screw.....
201018C	20807	" " Set Screw.....
202490	20778	" Stand with 200383C.....
225391	20778	Thread Guide.....
201696J	20807	" " Lock Nut.....
225326	20807	" " Position Cup.....

THREAD UNWINDER

No.	Plate	Name
225324	20778	Thread Guide Rod with 208E and 225322...
208E	7409	" " " Screw.....
225322	20807	" " " Washer.....
*150057	-----	" Separator.....
150058	20778	" " 150057 with 150059.....
*150059	-----	" " Bracket.....
150060	20778	" " " Arm with 164J and 9525.....
164J	20807	Thread Separator Bracket Arm Clamping Screw.....
9525	20807	Thread Separator Bracket Arm Clamping Screw Washer.....
164J	20807	Thread Separator Bracket Screw.....
9525	20807	" " " " Washer....
150061	-----	Thread Separator complete, Nos. 164J, 9525, 150058 and 150060.....
150178	20778	Thread Unwinder complete, Nos. 150061, 201696J, 202490, 225257, 225259, 225324, 225326, 225388 and three each 150203, 225391 and wood screws 7/8 in. No. 12
27739	20778	Thread Cone (wood) for large cones.....
225390	20778	" " Holder, for inverted cones..

Note: Nos. 27739 and 225390 are used with, but not included in 150178.

**Genuine Singer Needles should be used
in Singer Machines.
These Needles and their Containers
are marked with the
Company's Trade Mark "SIMANCO." 1**

**Needles in Containers marked
"For Singer Machines"
are not Singer made needles. 2**

NUMERICAL LIST OF PARTS

No.	Plate	Name
61C	7406	Feed (back) Bar Hinge Screw, for 132624..
69F	20857	" " Regulator Hinge Screw, for 132842.....
85D	20839	Presser Lever Lifter Hinge Screw.....
93C	20846	Needle Bar Thread Retainer Screw.....
133F	7409	Knife (movable) Holder Screw, for 42308 and 132627.....
157E	5569	Feed (front) Rock Shaft Crank Clamping Screw, for 42021.....
157E	5569	Knife Grinder Knife Holder Bracket Clamping Screw, for 41331.....
164J	20807	Thread Unwinder Thread Separator Bracket Arm Clamping Screw, for 150060.....
164J	20807	Thread Unwinder Thread Separator Bracket Screw, for 150061.....
171C	7407	Feed (front) Connecting Rod Hinge Screw Clamping Screw, for 132529.....
171F	7407	Needle Guard Screw.....
175E	20846	Knife (movable) Lever Connection Hinge Stud Set Screw, for 132821.....
176J	20846	Frame Top Cover Extension Screw, for 132800.....
176J	20846	Thread (looper, left hand) Nipper Spring Screw.....
176J	20846	Thread (looper, right hand) Staple Screw
185J	20865	" " " Take-up Screw
187E	20846	Needle Bar Connecting Bracket Clamping Screw, for 132598.....
190J	20846	Feed (back) Regulator Set Screw, for 81-70 and 81-76 Machines.....
190E	20846	Feed (front) Dog Screw, for 81-73 and 81-76 Machines.....
190E	20846	Frame Bottom Cover Screw.....
190J	20846	Welt Guide Screw, for 132758.....
193E	20856	Feed (back) Dog Screw.....
193E	20856	" (front) Dog Screw, for 81-70 Machine
197J	20846	Frame Top Cover Oil Reservoir Cover Screw, for 132781 and 132847.....
197J	20846	Looper (right hand) Screw.....
197J	20846	Thread (needle) Take-up Screw.....
201J	7407	Feed (front) Eccentric Clamping Washer Screw, for 132534 and 132644.....
207J	20846	Thread (looper, left hand) Pull-off Eye- let Screw.....
208E	7409	Thread Unwinder Thread Guide Rod Screw, for 225324.....

NUMERICAL LIST OF PARTS

No.	Plate	Name
217J	20846	Needle Bar Bushing (upper) Oil Pad Cover Screw, for 81-70 and 81-73 Machines.
217J	20846	Thread (needle) Eyelet Screw, for 81-76 Machine.....
223F	20846	Needle Bar Connecting Link Hinge Pin Set Screw, for 132598.....
223J	20846	Thread (needle) Eyelet Screw, for 81-70 and 81-73 Machines.....
228J	20846	Needle Bar Thread Retainer Bracket Screw for 81-76 Machine.....
228J	20846	Needle Bar Thread Retainer Bracket Screw (for two-thread stitch) for 81-70 and 81-73 Machines.....
233E	20816	Cloth Plate Extension (lower) Screw, for 132527.....
233E	20816	Cloth Plate Extension (upper) Screw, for 132527.....
233J	20816	Presser Foot Chaining-off Finger Screw, for 42185, 132681, 132857, 132880, 132877 and 132904.....
233J	20816	Presser Foot Edge Folder Screw, for 132898.....
233J	20816	Presser Foot Tape Guide Screw, for 132902.....
233E	20816	Thread (looper, left hand) Eyelet Screw, for 132799.....
236C	20821	Cloth Plate Lock Spring Screw, for 132527
240C	20846	Presser Foot Chaining-off Plate Collar Set Screw, for 132610.....
240C	20846	Feed (back) Regulator Indicator Screw, for 132842.....
241E	20846	Looper (right hand) and Spreader Lever Oil Plug Screw, for 132799.....
263W	7409	Frame Top Cover Extension Holder Thumb Screw.....
313C	5569	Knife Grinder Knife Holder Screw Center, for 150209 and 150210.....
330W	20821	Frame Side Cover (left) Screw.....
330W	20821	" " (right) Screw.....
336F	7409	Knife (movable) Holder Guide Set Screw, for 42038.....
356C	20807	Rock Shaft Knee Arm Hub Set Screw, for 2766.....
356C	20807	Rock Shaft Knee Plate Set Screw, for 2767
356C	20807	" " Lifting Bracket Hook Set Screw, for 6337.....
356C	20807	Rock Shaft Lifting Bracket Set Screw, for 6337.....
356C	20807	Rock Shaft Stop Dog Set Screw, for 2770..
404D	7409	Knife (movable) Holder Cap Screw, for 132627.....

NUMERICAL LIST OF PARTS

No.	Plate	Name
440C	7409	Knife (stationary) Holder Stop Screw....
446C	7409	Balance Wheel Set Screw, for 132632.....
462C	20846	Feed (front) Lifting Eccentric Set Screw for 132649.....
462C	20846	Needle Bar Bushing Set Screw, for 132522
462C	20846	Thread (looper, left hand) Tube Set Screw.....
464C	20816	Presser Foot Plate (back) Spring Adjusting Pin Set Screw, for 132857 and 132904.....
464C	20816	Presser Foot Spring Adjusting Pin Set Screw, for 42185.....
474J	20826	Machine Base Thumb Screw, for use when machine is mounted 1 1/2 in. lower than standard (Accessories).....
563F	20846	Frame Top Cover Screw (large).....
620C	20846	Needle Bar Connecting Link Hinge Pin Set Screw, for 132880.....
621E	7409	Knife (movable) Holder Guide Plate Screw
624C	20846	Needle Bar Crank (back) Bushing Set Screw, for 132522.....
717C	5569	Knife Grinder Knife Holder Bracket Stop Screw, for 41335 and 41819.....
735C	20846	Presser Foot Chaining-off Plate Collar Guide Pin Set Screw, for 132679, 132685 and 132900.....
742F	20846	Frame Top Cover Screw (small).....
742F	20846	Throat Plate Screw.....
771D	5569	Knife Grinder Knife Holder Clamp Thumb Screw, for 150209 and 150210.....
878D	5569	Knife Grinder Frame Oil Hole Stop Screw, for 41335 and 41819.....
896C	20817	Looper (right hand) and Spreader Lever Connection Cap (lower) Screw, for 132777.....
896C	20817	Looper (right hand) and Spreader Lever Connection Cap (upper) Screw, for 132777.....
896C	20817	Needle Bar Connecting Rod Cap (lower) Screw, for 132806.....
896C	20817	Needle Bar Connecting Rod Cap (upper) Screw, for 132806.....
935E	7419	Machine Base Cushion (small) Screw, for 132592 and 132656.....
949E	20846	Arm Screw.....
970D	5569	Knife Grinder Knife Holder Regulating Thumb Screw, for 150209 and 150210..
1036C	5569	Feed (front) Eccentric Body Set Screw, for 132534 and 132644.....
1036C	5569	Feed (front) Rock Shaft Hinge Pin Bushing Set Screw.....

From the library of: Diamond Needle Corp

NUMERICAL LIST OF PARTS

No.	Plate	Name
1036C	5569	Frame Rotary Shaft Crank Set Screw, for 132769.....
1036C	5569	Knife Grinder Emery Wheel Shaft Pulley Set Screw, for 41328.....
1036C	5569	Knife Grinder Knife Holder Bracket Hinge Stud Set Screw, for 41329.....
1036C	5569	Looper (left hand) Lever Hinge Stud Set Screw.....
1036C	5569	Looper (right hand) and Spreader Lever Hinge Pin Bushing Set Screw.....
1036C	5569	Looper (right hand) and Spreader Lever Hinge Pin Set Screw.....
1057C	7407	Feed (front) Connecting Rod Cap Screw, for 132529.....
1057C	7407	Knife (movable) Lever Connection Cap Screw, for 132563.....
1101C	20807	Knife (stationary) Holder Screw.....
1117J	20825	Welt Guide Regulating Thumb Screw, for 132758.....
1120C	20846	Presser Lever Hinge Stud Set Screw.....
1132C	7406	Feed (back) Bar Hinge Screw, for 132842.
1132C	7406	" " Connecting Link Hinge Screw, for 132624.....
1132C	7406	Feed (back) Regulator Hinge Screw, for 132624.....
1148F	20824	Lifting Lever Stop Screw, for 42133 and 42144.....
1204E	20824	Machine Base Position Stud, for 132656..
1209C	20825	Welt Guide Holder Screw, for 132758.....
1229C	20846	Knife (movable) Lever Hinge Stud Set Screw.....
1229C	20846	Lifting Lever Bracket Screw, for 42133 and 42144.....
1247C	20824	Machine Base Oil Drain Jar Clamp Lever Hinge Screw, for 131268 and 132697..
1253C	20846	Feed (front) Bar Hinge Pin Set Screw, for 42151 and 132671.....
1259C	20846	Needle Bar Crank (back) Ball Stud Set Screw, for 132879.....
1259C	20846	Needle Bar Crank (back) Set Screw, for 132879.....
1285C	20807	Balance Wheel Position Screw, for 132632
1301D	20865	Lifting Lever Hinge Screw, for 42133 and 42144.....
1324C	20824	Presser Foot Screw.....
1375C	20817	Frame Rotary Shaft Crank Position Screw, for 132769.....
1376C	20818	Knife (stationary) Holder Regulating Thumb Screw.....
1377C	20807	Presser Lever Screw Stud (eccentric)....

NUMERICAL LIST OF PARTS

No.	Plate	Name
1378D	20839	Pressure Regulating Thumb Screw.....
1408J	20826	Machine Base Thumb Screw, for 1 5/8 in. Tables and Individual Stands, for use when machine is mounted on top of table (Accessories).....
1430C	20857	Feed (back) Regulator Rack Pawl Hinge Screw, for 132842.....
1444C	7406	Feed (back) Regulator Thumb Screw, for 132541.....
1508C	5569	Knife Grinder Emery Wheel Clamping Nut, for 41335 and 41819.....
1519J	5569	Knife Grinder Knife Holder Screw Center Nut, for 150209 and 150210.....
1520J	5569	Feed (front) Connecting Rod Hinge Screw Nut.....
1520J	5569	Knife Grinder Knife Holder Bracket Stop Screw Nut, for 41335 and 41819.....
1534D	20818	Knife (stationary) Clamping Stud Thumb Nut.....
1547J	7409	Knife (stationary) Holder Stop Screw Nut.....
1547J	7409	Lifting Lever Stop Screw Nut, for 42133 and 42144.....
1547J	7409	Presser Lever Screw Stud Nut.....
1684E	20817	Frame Rotary Shaft Crank Ball Sleeve Bushing Nut, for 132775.....
1695J	7407	Feed (front) Connecting Rod Hinge Screw Clamping Screw Nut, for 132529.....
1728C	20846	Needle Clamping Nut.....
1735J	20861	Looper (left hand) Lever Connecting Link Screw Nut, for 132801.....
2102	20865	Tension (looper, left hand) Disc.....
2102	20865	" (looper, right hand) Disc.....
2102	20865	" (needle thread) Disc.....
2763	20808	Rock Shaft, for 42143.....
2765	20808	" " Knee Arm, for 2768.....
2766	20808	" " " " Hub with 356C, for 2768.....
2767	20808	Rock Shaft Knee Plate with 356C, for 2768.....
2768	----	Rock Shaft Knee Arm complete, Nos. 2765 to 2767, for 42143.....
2770	20808	Rock Shaft Stop Dog with 356C, for 42143
4389	20821	Arm Dowel Pin.....
4822	5566	Wrench for 1547 (Accessories).....
4879	5566	Chain Connection Link, for 4885.....
4881	20808	Treadle, for 4885.....
4882	5566	" Shaft, for 4885.....
4883	5566	" Spring, for 4885.....
4884	20808	" Stand, for 4885.....

From the library of: Diamond Needle Corp

NUMERICAL LIST OF PARTS

No.	Plate	Name
4885	20808	Treadle complete, Nos. 4879, 4881 to 4884 and two wood screws 1 in. No. 16, for 42133.....
6337	20808	Rock Shaft Lifting Bracket with two 356C, for 42143.....
6439	-----	Chain, 36 in. to 45 in., with 56864 and 56865, for 42133.....
7071	20821	Thread (looper, right hand) Staple Screw Washer.....
7125	20808	Rock Shaft Lifting Bracket Hook, for 42143.....
8908	5566	Wrench for 1520 (Accessories).....
9320	20816	Presser Foot Plate (back) Hinge Pin, for 132857 and 132904.....
9320	20816	Presser Foot Hinge Pin, for 42185.....
9525	20807	Thread Unwinder Thread Separator Bracket Arm Clamping Screw Washer, for 150060.....
9525	20807	Thread Unwinder Thread Separator Bracket Screw Washer, for 150061.....
9842	7419	Machine Base Thumb Screw Spring Washer (Accessories).....
9842	7419	Machine Base Screw Stud Nut Washer, for 132592.....
10107	20863	Needle Bar Thread Retainer Spring.....
12242	20808	Rock Shaft Hanger with two wood screws 1 in. No. 10, for 42143.....
14058	20816	Presser Foot Chaining-off Plate Spring, for 132881, 132860, 132877, 132898 and 132902.....
14058	20816	Presser Foot Plate (back) Spring, for 132857 and 132904.....
14058	20816	Presser Foot Spring, for 42185.....
14063	20807	Machine Base Thumb Screw Spring, for Thumb Screw No. 1408, when machine is mounted on Individual Stand (Accessories).....
14222	5569	Knife Grinder Knife Holder Clamp Steady Pin, for 41330 and 41818.....
*15404	-----	Trade Mark, for 132522.....
15405	-----	" Rivet, for 132522.....
19044	7407	Frame Top Cover Extension Holder Thumb Screw Washer.....
19047	7407	Feed (front) Eccentric Clamping Washer, for 132534 and 132644.....
22436	20825	Welt Guide Holder Screw Washer, for 132758.....
27498	20826	Machine Base Thumb Screw Spring, for Thumb Screw No. 1408, on 1 5/8 in. Tables and Thumb Screw No. 474, when machine is mounted 1 1/2 in. lower than standard (Accessories).....

NUMERICAL LIST OF PARTS

No.	Plate	Name
27739	20778	Thread Unwinder Thread Cone (wood) for large cones.....
27998	20807	Bench Stand Cover Hook and Eye (brass) with wood screw 1/2 in. No. 5 F.H., for 79768 and 79790.....
28291	20807	Bench Stand Cover Hinge with two each wood screws 1/2 in. No. 5 F.H., and 5/8 in. No. 5 F.H. for 79768 and 79790
39541	20824	Presser Foot Screw Washer.....
41326	20847	Knife Grinder Emery Wheel, for 41335 and 41819.....
41327	20847	Knife Grinder Emery Wheel Shaft, for 41335 and 41819.....
41328	20847	Knife Grinder Emery Wheel Shaft Pulley with 1036C, for 41335 and 41819....
41329	20830	Knife Grinder Frame with 1036C, for 41335 and 41819.....
41330	20874	Knife Grinder Knife Holder with two 14222, for 150209.....
41331	20847	Knife Grinder Knife Holder Bracket with 157E, for 150209 and 150210.....
41332	5569	Knife Grinder Knife Holder Spring, for 150209 and 150210.....
41333	5569	Knife Grinder Knife Holder Clamp, for 150209 and 150210.....
41334	5569	Knife Grinder Knife Holder Clamp Spring for 150209 and 150210.....
41335	-----	Knife Grinder complete, for 81-76 Machine, Nos. 717C, 1508C, 1520J, 41326 to 41329, 42065, 150209, two each 878D, 41513 and three wood screws 1 1/4 in. No. 12.....
41513	5569	Knife Grinder Emery Wheel Washer, for 41335 and 41819.....
41818	20847	Knife Grinder Knife Holder with two 14222, for 150210.....
41819	-----	Knife Grinder complete, for 81-70 and 81-73 Machines, Nos. 717C, 1508C, 1520J 41326 to 41329, 42065, 150210, two each 878D, 41513 and three wood screws 1 1/4 in. No. 12.....
42005	20821	Cloth Plate Lock Spring, for 132527....
42021	20858	Feed (front) Rock Shaft Crank with 157E for 132541 and 132845.....
42028	20855	Frame Side Cover (right) hinged.....
42035	7409	Knife (movable) Holder, for 132627.....
42037	7409	" " " Cap, for 132627.
42038	7409	" " " Guide with 336F.
42039	7409	" " " Plate.....
42040	7409	" " " Screw Extension Pin, for 42308 and 132627.....

NUMERICAL LIST OF PARTS

No.	Plate	Name
42041	7409	Knife (movable) Holder Spring.....
42045	20834	" " Lever Hinge Stud.....
42045	20834	Presser Lever Hinge Stud, for 42376.....
42046	20860	Knife (stationary) with 42049, for 81-76 Machine.....
42048	20860	Knife (stationary) Clamping Stud, for 81-76 Machine.....
42049	20818	Knife (stationary) Stud, for 42046 and 42309.....
42050	20861	Looper (left hand).....
42054	20863	Needle Bar.....
42065	5569	Knife Grinder Knife Holder Bracket Hinge Stud, for 41335 and 41819.....
42066	20863	Needle Guard.....
42069	20839	Presser Lever, for 42376.....
42070	20839	" " Lifter.....
42071	20839	" " Spring.....
42082	20866	Tension (needle thread) Thread Guide, for 81-76 Machine.....
42082	20866	Tension (needle thread) Thread Guide (for two-thread stitch) for 81-70 and 81-73 Machines.....
42084	20865	Thread (looper, left hand) Tube.....
42088	7419	Machine Base Cushion (small) felt, for 132592 and 132656.....
42089	5566	Wrench for 1324 and 1728 (Accessories).....
42090	5566	Threading Wire (Accessories).....
42096	20866	Thread (needle) Eyelet, for 81-76 Machine.....
42096	20866	" " (for two-thread stitch) for 81-70 and 81-73 Machines.....
42101	20821	Frame Side Cover (right) Lock Spring, for 132600.....
42102	7409	Frame Top Cover Extension Holder, for 132600.....
42108	20821	Cloth Plate Extension (upper) for 132527.....
42115	20863	Needle Bar Thread Retainer Bracket.....
42122	20844	Thread (looper, left hand) Nipper Spring (lower).....
42123	20844	Thread (looper, left hand) Nipper Spring (upper).....
42126	20844	Thread (looper, right hand) Pull-off....
42128	20866	" (needle) Take-up, for 81-76 Machine.....
42130	20824	Lifting Lever, for 42133 and 42144.....
42131	20824	" " Bracket, for 42133 and 42144.....
42132	20824	Lifting Lever Spring, for 42133 and 42144.....
42133	-----	Foot Lifter complete, Nos. 1301D, 4885, 6439 42130 to 42132 and two each 1148F, 1229C and 1547J.....

NUMERICAL LIST OF PARTS

No.	Plate	Name
42137	20873	Tape Guide, for inserting tape and folding the edge on the top of seat covers, for 81-73 Machine.....
42142	20808	Lifting Lever Connecting Rod, for 42144.....
42143	20808	Rock Shaft complete, Nos. 2763, 2768, 8337, 7125 and two each 2770 and 12242, for 42144.....
42144	-----	Knee Lifter complete, Nos. 1301D, 42130 to 42132, 42142, 42143 and two each 1148F 1229C and 1547J.....
42147	7406	Feed (back) Bar, for 132624.....
42148	7406	" " Connecting Link, for 132624.....
42149	20816	" " Dog, 3 teeth (16 teeth to the inch) for knit goods, for 42452 and 132858, for 81-70 and 81-76 Machines.....
42150	7406	Feed (back) Regulator, for 132624.....
42151	7406	" (front) Bar with 1253C, for 132624.....
42158	20856	Presser Foot Chaining-off Finger, for 132857.....
42159	-----	Presser Foot Plate, for 42185.....
42160	20816	" " (back) Spring Adjusting Pin, for 132857 and 132904.....
42160	20816	Presser Foot Spring Adjusting Pin, for 42185.....
42182	20816	Feed (front) Dog, 17 teeth (16 teeth to the inch) for knit goods, for 42452, for 81-76 Machine.....
42183	-----	Presser Foot Body, for 42185.....
42184	20816	" " Chaining-off Finger, for 42185.....
42185	20816	Presser Foot (spring hinged) complete, for 81-76 Machine, Nos. 233J, 464C, 9320 14058, 42159, 42160, 42183 and 42184.....
42188	20825	Welt Guide (hinged) complete, for 81-76 Machine, Nos. 42473, 42474, 42476, 132869 and two 42477.....
42213	7409	Knife (movable) for 81-76 Machine.....
42214	7409	" " Gib, for 132627.....
42242	20866	Thread (looper, left hand) Eyelet, for 132801.....
42244	20844	Thread (looper, left hand) Pull-off Eyelet.....
42253	20863	Needle Bar Bushing (lower) for 132522.....
42264	-----	Presser Foot Shank, for 132857 and 132904.....
42288	20867	" " Chaining-off Finger, for 132904.....
42305	20818	Knife (movable) for 81-70 and 81-73 Machines.....
42306	20818	Knife (movable) Gib, for 42308.....
42307	20818	" " Holder, for 42308.....

NUMERICAL LIST OF PARTS

No.	Plate	Name
42308	-----	Knife (movable) Holder 42307 with 133F, 42040 and 42306, for 81-70 and 81-73 Machines.....
42309	20818	Knife (stationary) with 42049, for 81-70 and 81-73 Machines.....
42310	20818	Knife (stationary) Clamping Stud, for 81-70 and 81-73 Machines.....
42378	-----	Presser Lever 42069 with 42045.....
42405	20856	" Foot Plate (back) for 132857 and 132904.....
42452	20816	Throat Plate, for knit goods, for 42149 and 42182, for 81-76 Machine.....
42461	20856	Presser Foot Plate (front) Hinge Pin, for 132857.....
42461	20856	Presser Foot Hinge Pin, for 132860, 132877, 132898 and 132904.....
42473	20825	Welt Guide, for 42188.....
42474	20825	" " Hinge Pin, for 42188.....
42475	20825	" " " (female half) for 132869.....
42476	20825	" " " (male half) for 42188.....
42477	20825	" " " Rivet, for 42188 and 132869.....
42478	20825	Welt Guide Spring, for 132869.....
42483	20863	Needle Bar Thread Retainer Disc.....
42491	20867	Feed (front) Dog, 29 teeth (22 teeth to the inch) for light knit material, for 132903, for 81-70 Machine.....
42492	20867	Feed (back) Dog, 4 teeth (22 teeth to the inch) for light knit material, for 132903, for 81-70 Machine.....
46548	20807	Bench Stand Cover Rest (felt) for 79768 and 79790.....
50117C	20846	Looper (left hand) Clamping Screw, for 132795.....
50148C	20865	Tension (looper, right hand) Screw Stud, for 132871.....
50150C	20821	Cloth Plate Hinge Stud Set Screw.....
50200C	20848	Needle Bar Crank (front) Set Screw, for 132880.....
50253J	7407	Feed (front) Eccentric Cover Screw, for 132600.....
50261C	20865	Tension (needle thread) Screw Stud, for 132360.....
50326C	20865	Tension (looper, left hand) Screw Stud, for 59539.....
51145C	7407	Feed (front) Regulating Screw, for 132534 and 132644.....
51292C	7407	Feed (front) Connecting Rod Hinge Screw.....
51332C	20821	Frame Rotary Shaft Bushing (front) Set Screw.....

NUMERICAL LIST OF PARTS

No.	Plate	Name
51332C	20821	Frame Rotary Shaft Flanged Bushing (back) Set Screw.....
51459E	20861	Looper (left hand) Lever Connecting Link Screw, for 132801.....
51570C	20865	Tension (looper, left hand) Regulating Thumb Nut, for 59539.....
51570C	20865	Tension (looper, right hand) Regulating Thumb Nut, for 132871.....
51570C	20865	Tension (needle thread) Regulating Thumb Nut, for 132360.....
51576E	7419	Machine Base Screw Stud Nut, for 132592.....
52130	20865	Thread (needle) Eyelet Bushing, for 132873.....
52130	20865	Thread (needle) Take-up Staple and Thread Guide Bushing, for 132875.....
54477	7419	Machine Base Screw Stud, for 132592.....
56864	5566	Chain Hook (large) for 6439.....
56865	20807	Bench Stand Cover Chain Hook, for 60820.....
56865	20807	Chain Hook (small) for 6439.....
57078	20866	Tension (looper, right hand) Thread Guide.....
59534	20865	Tension (looper, left hand) Spring.....
59535	20865	" (looper, right hand) Spring.....
59535	20865	" (needle thread) Spring.....
59537	20865	" (looper, left hand) Spring Bushing (large).....
59537	20865	Tension (looper, right hand) Spring Bushing (large).....
59537	20865	Tension (needle thread) Spring Bushing (large).....
59538	20865	Tension (looper, left hand) Spring Bushing (small).....
59538	20865	Tension (looper, right hand) Spring Bushing (small).....
59538	20865	Tension (needle thread) Spring Bushing (small).....
59539	-----	Tension (looper, left hand) Screw Stud 50326C with 51570C.....
60820	-----	Bench Stand Cover Chain, 9 1/4 in. long, with two 56865, for 79790.....
66707	-----	Machine Base Cushion (small) Screw Washer, for 132592 and 132656.....
68350	20821	Arm Oil Cup.....
79768	-----	Bench Stand with 27998, two each 28291, 46548 and wood screws 1 1/2 in. No. 14 F.H., for Machine Base No. 132592 for use when machine is mounted on top of table.....

NUMERICAL LIST OF PARTS

No.	Plate	Name
79790	-----	Bench Stand with 27998, 60820, two each 28291, 46548, 150244 and three each wood screws 1 1/4 in. No. 12 F.H. and 1 1/2 in. No. 14 F.H., for Machine Base No. 132656, for use when machine is mounted 1 1/2 in. lower than standard.....
120341	5566	Tweezers (curved) Accessories.....
120344	5566	Oiler (copper plated) with 120345 (Accessories).....
120345	5566	Oiler Spout, 4 1/2 in. long, for 120344 (Accessories).....
120440	5566	Screw Driver (machine) Accessories.....
125056	20862	Looper (right hand) and Spreader Lever Hinge Pin Oil Wick (braided cotton) for 132699.....
131022	20824	Machine Base Position Stud Bushing (rubber) for 132656.....
131185	20828	Machine Base Oil Drain Jar (glass) for 131268 and 132697.....
131188	20828	Machine Base Oil Drain Jar Clamp, for 131217.....
131189	20828	Machine Base Oil Drain Jar Clamp Lever, for 131217.....
131191	20828	Machine Base Oil Drain Jar Cap, for 131268 and 132697.....
131217	-----	Machine Base Oil Drain Jar Clamp 131188 with 131189, for 131268 and 132697..
131265	20828	Machine Base Oil Drain Jar Nipple (long) for 131268 and 132697.....
131266	20828	Machine Base Oil Drain Jar Nipple (short) for 131268 and 132697.....
131267	20828	Machine Base Oil Drain Jar Nipple Elbow, for 131268 and 132697.....
131268	-----	Machine Base Oil Drain Jar (swinging type) complete, for Machine Base No. 132592, for Bench Stand No. 79768, Nos. 131185, 131191, 131217, 131266 and two each 1247C, 131265 and 131267, for 132704.....
132360	-----	Tension (needle thread) Screw Stud 50261C with 51570C.....
*132522	-----	Arm with 15404, 42253, 132580 and two each 482C, 624C, 15405 and 132589.....
132524	20808	Cloth Plate with 132525, for 132527.....
*132525	-----	" " Hinge Bracket, for 132524....
132526	20821	" " Stud.....
132527	-----	Cloth Plate complete, Nos. 42005, 42108, 132524, 132601, two 236C and five 233E
132528	7406	Feed (front) Bar Hinge Pin, for 132624 and 132642.....

NUMERICAL LIST OF PARTS

No.	Plate	Name
132529	7407	Feed (front) Connecting Rod with 171C, 1895J and two 1057C, for 132619 and 132643.....
*132531	-----	Feed (front) Eccentric, for 132534 and 132644.....
*132532	-----	Feed (front) Eccentric Body, for 132644.
132533	7407	" " " Oil Tube, for 132534 and 132644.....
132534	7407	Feed (front) Eccentric complete, Nos. 201J, 19047, 51145C, 132531, 132533, 133702 and two 1036C, for 132619...
132537	20858	Feed (front) Eccentric Lubricator Oil Wick (braided cotton) for 132785...
132539	20858	Feed (front) Lifting Eccentric Connection, for 132624 and 132842.....
132540	7406	Feed (front) Rock Shaft, for 132541....
132541	-----	Feed (front) Rock Shaft complete, Nos. 1444C, 42021 and 132540, for 132624.
132542	20859	Feed (front) Rock Shaft Hinge Pin with 132544.....
132543	20859	Feed (front) Rock Shaft Hinge Pin Bushing.....
132543	20859	Looper (right hand) and Spreader Lever Hinge Pin Bushing.....
132544	20859	Feed (front) Rock Shaft Hinge Pin Oil Wick (braided cotton) for 132542...
*132545	-----	Frame.....
132546	20808	" Bottom Cover with 132594.....
132547	20808	" " " Gasket.....
132548	20821	" Oil Cup.....
132552	20861	Looper (left hand) Lever Hinge Stud Oil Pad (braided cotton) for 132798....
132558	20823	Frame Rotary Shaft Oil Pad (braided cotton) for 132819.....
132559	20823	Frame Rotary Shaft Oil Pad Retainer, for 132819.....
132560	20855	Frame Side Cover (left) with 132701....
132563	20834	Knife (movable) Lever Connection with two 1057C, for 132620.....
132565	20834	Knife (movable) Lever Connection Hinge Stud.....
132580	20863	Needle Bar Bushing (upper) for 132522..
132581	20863	" " " " Oil Pad (braided cotton).....
132582	20863	Needle Bar Connecting Link, for 132882.
132583	20863	" " " Hinge Pin with 132584, for 132882.....
132584	20863	Needle Bar Connecting Link Hinge Pin Oil Pad (wick) for 132583.....
132589	20864	Needle Bar Crank (back) Bushing, for 132522.....

NUMERICAL LIST OF PARTS

No.	Plate	Name
132590	20864	Needle Bar Crank (back) Oil Pad (wick) for 132879.....
132591	20844	Thread (looper, left hand) Pull-off.....
132592	-----	Machine Base complete, Nos. 132593, 132596, 132618, 132647, three each 9842, 51576E 54477 and four each 935E, 42088, 66707 and 132595, for 132704.....
132593	7419	Machine Base Oil Drain Strainer, for 132592 and 132656.....
132594	7419	Machine Base Thumb Screw Bushing, for 132546.....
132595	7419	Machine Base Cushion (large) felt, for 132592 and 132656.....
132596	7419	Machine Base Cushion (leather) for 132592 and 132656.....
132598	20863	Needle Bar Connecting Bracket with 187E and 223E, for 132882.....
132599	20865	Tension (looper, left hand) Thread Guide
132600	-----	Frame Top Cover Extension Holder 42102 with 42101, 132650, 132651 and two each 176J and 50253J.....
132601	20808	Cloth Plate Extension (lower) for 132527
132602	20807	Machine Base Thumb Screw Washer (Accessories).....
132603	20834	Frame Rotary Shaft Flanged Bushing (back) Oil Pad Retainer, for 132866.
132608	20853	Presser Foot Chaining-off Finger, for 132860.....
132609	20868	Presser Foot Chaining-off Plate, for 132681, 132860, 132877 and 132902.....
132610	20868	Presser Foot Chaining-off Plate Collar with 240C, for 132681, 132860, 132877, 132898 and 132902.....
132611	20868	Presser Foot Chaining-off Plate Collar Guide Pin, for 132681, 132860, 132877, 132898 and 132902.....
132618	7419	Machine Base Cushion (small) felt, for 474 or 1408, for 132592 and 132656..
132619	-----	Feed (front) Connecting Rod 132529 with 132534, for 81-70 and 81-76 Machines
132620	-----	Knife (movable) Lever Connection 132563 with 132649.....
132621	20863	Needle Bar Bushing (upper) Oil Pad Cover for 81-70 and 81-76 Machines.....
*132624	-----	Feed (front) Bar 42151 with 61C, 42147, 42148, 42150, 132528, 132539, 132541 and two 1132C, for 81-70 and 81-76 Machines.....
132627	-----	Knife (movable) Holder 42035 with 133F, 42037, 42040, 42214 and two 404D, for 81-76 Machine.....

NUMERICAL LIST OF PARTS

No.	Plate	Name
132630	20862	Looper (right hand).....
132631	20862	Spreader, for two-thread stitch, for 81-70 and 81-73 Machines.....
132632	20855	Balance Wheel, 1 7/8 in. pulley with 446C and 1285C.....
132643	-----	Feed (front) Connecting Rod 132529 with 132644, for 81-73 Machine.....
132644	20857	Feed (front) Eccentric (adjustable) complete, Nos. 201J, 19047, 51145C, 132531 to 132533 and two 1036C, for 132643.
132647	20808	Machine Base, for 132592.....
132649	20858	Feed (front) Lifting Eccentric with two 462C, for 132620.....
132650	7409	Frame Top Cover Extension, for 132600..
132651	7407	Feed (front) Eccentric Cover, for 132600
132654	20855	Chip Guard.....
132655	20830	Machine Base, for 132656.....
132656	-----	Machine Base complete, Nos. 132593, 132596, 132618, 132655, three each 1204E 131022 and four each 935E, 42088, 66707 and 132595, for 132705.....
132664	20844	Thread (looper, right hand) Staple.....
132665	20860	Feed (back) Bar, for 132842.....
132666	20860	" " " Hinge Pin (hollow) for 132842.....
132667	20860	Feed (back) Connecting Link, for 132842
132671	20857	" (front) Bar with 1253C, for 132842
132679	-----	Presser Foot Body with 735C, for 132681
132680	20868	" " Chaining-off Finger, for 132681.....
132681	20868	Presser Foot (solid) complete, for knit goods, for 81-73 Machine, Nos. 233J 14058, 132609 to 132611, 132679 and 132680.....
132683	-----	Presser Foot Plate, for 132860.....
132685	-----	" " Shank with 735C, for 132860, 132877 and 132898.....
132689	20869	Throat Plate, for knit goods, for 3/16 in. to 1/4 in. bight, for 132836 and 132843, for 81-73 Machine.....
132690	20871	Throat Plate, for rayon, for 132848 and 132849, for 81-73 Machine.....
*132692	20834	Frame Rotary Shaft Oil Sling Cover, for 132866.....
132697	-----	Machine Base Oil Drain Jar (swinging type) complete, for Machine Base No. 132656, for Bench Stand No. 79790, Nos. 131185, 131191, 131217, 131265 and two each 1247C, 131266 and 131267, for 132705.....

NUMERICAL LIST OF PARTS

No.	Plate	Name
132699	20862	Looper (right hand) and Spreader Lever Hinge Pin with 125056, for 132800..
132701	20821	Frame Side Cover (left) Handle, for 132560.....
*132702	-----	Feed (front) Eccentric Body, for 132534.
132704	-----	Machine Base and Oil Drain Jar complete, for Machine Base No. 132592, when machine is mounted on top of table, for use with Bench Stand No. 79768, Nos. 131268 and 132592.....
132705	-----	Machine Base and Oil Drain Jar complete, for Machine Base No. 132656, when machine is mounted 1 1/2 in. lower than standard, for use with Bench Stand No. 79790, Nos. 132656 and 132697.....
132710	20825	Welt Guide Holder, for 132758.....
132712	20858	Feed (front) Eccentric Lint Cover (spring).....
132715	20817	Frame Rotary Shaft Bushing (front) Oil Pad Retainer, for 132863.....
*132758	-----	Welt Guide Holder 132710 with 190J, 1117J 1209C and 22436, for 81-76 Machine..
132766	20860	Knife (stationary) Holder, for 81-76 Machine.....
132767	20818	Knife (stationary) Holder, for 81-70 and 81-73 Machines.....
132769	20817	Frame Rotary Shaft Crank with 1036C, 1375C and 132773, for 132775.....
132770	20817	Frame Rotary Shaft Crank Ball Sleeve, for 132775.....
132771	20817	Frame Rotary Shaft Crank Ball Sleeve Bushing, for 132775.....
132772	20817	Frame Rotary Shaft Crank Ball Sleeve Bushing Nut Washer, for 132775.....
132773	20846	Frame Rotary Shaft Crank Ball Sleeve Bushing Position Pin, for 132769....
132774	20817	Frame Rotary Shaft Ball Sleeve Guide, for 132820.....
132774	20817	Frame Rotary Shaft Crank Ball Sleeve Guide, for 132779.....
132775	-----	Frame Rotary Shaft Crank complete, Nos. 1664E and 132769 to 132772, for 132779.....
132777	20817	Looper (right hand) and Spreader Lever Connection with four 896C, for 132779
132779	-----	Looper (right hand) and Spreader Lever Connection 132777 with 132774, 132775 and 132802.....
132780	20808	Frame Top Cover, for 132781.....

NUMERICAL LIST OF PARTS

No.	Plate	Name
132781	-----	Frame Top Cover 132780 with 132782 to 132784 and two 197J, for 81-70 and 81-76 Machines.....
132782	20821	Frame Top Cover Oil Reservoir Cover, for 132781 and 132847.....
132783	20821	Frame Top Cover Oil Tube, for 132781 and 132847.....
132784	20821	Frame Top Cover Oil Wick, for 132781 and 132847.....
132785	20858	Feed (front) Eccentric Lubricator with 132537.....
132790	20834	Frame Rotary Shaft Ball Sleeve, for 132820.....
132795	20861	Looper (left hand) Lever with 50117C, for 132801.....
132796	20861	Looper (left hand) Lever Connecting Link for 132801.....
132797	20861	Looper (left hand) Lever Connecting Link Hinge Pin, for 132801.....
132798	20861	Looper (left hand) Lever Hinge Stud with 132552, for 132801.....
132799	20862	Looper (right hand) and Spreader Lever with 233E, 241E and 140123C, for 132800.....
132800	-----	Looper (right hand) and Spreader Lever 132799 with 132699, for 132801.....
132801	-----	Looper (right hand) and Spreader Lever 132800 with 42242, 132795, 132798 and two each 1735J, 51459E, 132796 and 132797.....
132802	20817	Looper (right hand) and Spreader Lever Ball Stud, for 132779.....
132802	20817	Needle Bar Crank (back) Ball Stud, for 132820.....
132806	20864	Needle Bar Connecting Rod with four 896C for 132820.....
132812	20865	Thread (looper, right hand) Take-up.....
132816	20823	Feed (front) Rock Shaft Hinge Pin Bushing Oil Wick (wick).....
132816	20823	Looper (left hand) Lever Hinge Stud Oil Wick (wick).....
132816	20823	Looper (right hand) and Spreader Lever Hinge Pin Bushing Oil Wick (wick)...
132817	20823	Frame Rotary Shaft Bushing (front) Oil Wick (wick).....
132817	20823	Frame Rotary Shaft Flanged Bushing (back) Oil Wick (wick).....
132819	20855	Frame Rotary Shaft with 132558 and 132559, for 132820.....
132820	-----	Frame Rotary Shaft 132819 with 132774, 132790, 132802 and 132806.....
132821	20834	Knife (movable) Lever with 175E.....

NUMERICAL LIST OF PARTS

No.	Plate	Name
132835	20817	Frame Rotary Shaft Crank Oil Sling Cover for 132863.....
132836	20868	Feed (back) Dog (16 teeth to the inch) for knit goods, for 132889 and 132920, for 81-73 Machine.....
132837	20857	Feed (back) Regulator, for 132842.....
132838	20857	" " " Indicator, for 132842.....
132839	20857	Feed (back) Regulator Rack, for 132842..
132840	20857	" " " Pawl, for 132842.....
132841	20857	Feed (back) Regulator Rack Pawl Spring, for 132842.....
*132842	-----	Feed (front) Bar 132871 with 69F, 1132C, 1430C, 132528, 132539, 132665 to 132667, 132837 to 132841, 132845 and two 240J for 81-73 Machine.....
132843	20868	Feed (front) Dog (16 teeth to the inch) for knit goods, for 132689 and 132920 for 81-73 Machine.....
132844	20859	Feed (front) Rock Shaft, for 132845.....
132845	-----	Feed (front) Rock Shaft complete, Nos. 42021 and 132844, for 132842.....
132846	20874	Frame Top Cover, for 132847.....
132847	-----	" " " 132846 with 132782 to 132784 and two 197J, for 81-73 Machine.....
132848	20870	Feed (back) Dog (22 teeth to the inch) for rayon, for 132690 and 132850, for 81-73 Machine.....
132849	20870	Feed (front) Dog (22 teeth to the inch) for rayon, for 132690 and 132850, for 81-73 Machine.....
132850	20870	Throat Plate, for rayon, for 132848 and 132849, for 81-73 Machine.....
132855	20856	Feed (front) Dog, 22 teeth (16 teeth to the inch) for knit goods, for 132858 for 81-70 Machine.....
132856	-----	Presser Foot Plate, for 132877.....
132856	-----	" " " (front) for 132857 and 132904.....
132857	20856	Presser Foot (spring hinged) complete, for knit goods, for 81-70 Machine, Nos. 233J, 464C, 9320, 14058, 42158, 42160 42264, 42405, 42461 and 132856.....
132858	20856	Throat Plate, for 42149 and 132855, for 81-70 Machine.....
132859	20853	Feed Dog, 35 teeth (22 teeth to the inch) for rayon, for 132861, for 81-70 Machine.....

NUMERICAL LIST OF PARTS

No.	Plate	Name
132860	20853	Presser Foot (spring hinged) complete, for rayon, for 81-70 Machine, Nos. 233J, 14058, 42461, 132608 to 132611, 132683 and 132685.....
132861	20853	Throat Plate, for rayon, for 132859, for 81-70 Machine.....
*132862	-----	Frame Rotary Shaft Bushing (front) for 132863.....
132863	20817	Frame Rotary Shaft Bushing (front) 132862 with 132835, 132864 and two 132715.....
132864	20823	Frame Rotary Shaft Bushing (front) Oil Pad (braided cotton) for 132863.....
*132865	20855	Frame Rotary Shaft Flanged Bushing (back) for 132866.....
132866	-----	Frame Rotary Shaft Flanged Bushing (back) 132865 with 132692, 132867, 132868 and two 132603.....
132867	20823	Frame Rotary Shaft Flanged Bushing (back) Oil Pad (large) for 132866..
132868	20823	Frame Rotary Shaft Flanged Bushing (back) Oil Pad (small) braided cotton, for 132866.....
132869	-----	Welt Guide Spring 42478 with 42475 and two 42477, for 42188.....
132871	-----	Tension (looper, right hand) Screw Stud 50148C with 51570C.....
132872	20844	Thread (looper, right hand) Controller..
132873	20865	" (needle) Eyelet with 52130, for 81-70 and 81-73 Machines.....
132875	20844	Thread (needle) Take-up Staple and Thread Guide with two 52130, for 81-70 and 81-73 Machines.....
132876	20870	Presser Foot Chaining-off Finger, for 132877.....
132877	20870	Presser Foot (hinged) complete, for rayon, for 81-73 Machine, Nos. 233J, 14058, 42461, 132609 to 132611, 132855, 132856 and 132876.....
132879	20864	Needle Bar Crank (back) with 132590 and two 1259C.....
132880	20864	Needle Bar Crank (front) with 620C, 50200C and 140123C, for 132882.....
132882	-----	Needle Bar Crank (front) 132880 with 132582, 132598 and two 132583.....
132883	20866	Thread (needle) Take-up, for two-thread stitch, for 81-70 and 81-73 Machines
132889	20872	Feed (back) Dog (16 teeth to the inch) for folding the edge on the top of wash cloths, for inserting tape and folding the edge on the top of seat covers, for 132899, for 81-73 Machine

NUMERICAL LIST OF PARTS

No.	Plate	Name
132893	20872	Feed (front) Dog (16 teeth to the inch) for folding the edge on the top of wash cloths, for inserting tape and folding the edge on the top of seat covers, for 132899, for 81-73 Machine.....
132894	20872	Presser Foot Chaining-off Plate, for 132898.....
132895	20872	Presser Foot Edge Folder, for 132898 and 132902.....
132896	20872	Presser Foot Edge Folder Plate, for 132898.....
132897	-----	Presser Foot Plate, for 132898.....
132898	20872	Presser Foot (spring hinged) complete, for folding the edge on the top of wash cloths, for 81-73 Machine, Nos. 233J, 14058, 42461, 132610, 132611, 132685 and 132894 to 132897.....
132899	20872	Throat Plate, for folding the edge on the top of wash cloths and for inserting tape and folding the edge on the top of seat covers, for 132892 and 132893.....
132900	-----	Presser Foot Body with 735C, for 132902.
132901	20873	" " Tape Guide, for 132902.....
132902	20873	Presser Foot (solid) complete, for inserting tape and folding the edge on the top of seat covers, for 81-73 Machine, Nos. 233J, 14058, 132809 to 132611, 132895, 132900 and 132901.....
132903	20867	Throat Plate, for light knit material, for 42491 and 42492, for 81-70 Machine.....
132904	20867	Presser Foot (spring hinged) complete, for light knit material, for 81-70 Machine, Nos. 233J, 464C, 9320, 14058, 42160, 42264, 42288, 42405, 42461 and 132856.....
132914	20866	Thread (needle) Take-up, for 81-70 and 81-73 Machines.....
132920	20868	Throat Plate, for knit goods, for 1/8 in. to 3/16 in. bight, for 132836 and 132843, for 81-73 Machine.....
140123C	20846	Looper (right hand) and Spreader Lever Ball Stud Set Screw, for 132799.....
140123C	20846	Needle Bar Crank (front) Position Screw, for 132880.....
*150057	-----	Thread Unwinder Thread Separator, for 150058.....
150058	20778	Thread Unwinder Thread Separator 150057 with 150059, for 150061.....

NUMERICAL LIST OF PARTS

No.	Plate	Name
*150059	-----	Thread Unwinder Thread Separator Bracket for 150058.....
150060	20778	Thread Unwinder Thread Separator Bracket Arm with 164J and 9525, for 150061..
150061	-----	Thread Unwinder Thread Separator complete, Nos. 164J, 9525, 150058 and 150060, for 150178.....
150178	20778	Thread Unwinder complete, Nos. 150061, 201696J, 202490, 225257, 225259, 225324, 225326, 225388 and three each 150203, 225391 and wood screws 7/8 in. No. 12
150203	20778	Thread Unwinder Spool Rest Cushion (felt) for 150178.....
150209	-----	Knife Grinder Knife Holder 41330 with 970D, 41331, 41332 and two each 313C, 771D, 1519J, 41333 and 41334, for 41335
150210	-----	Knife Grinder Knife Holder 41818 with 970D, 41331, 41332 and two each 313C, 771D, 1519J, 41333 and 41334, for 41819
150244	20826	Bench Stand Cover Chain Hook Screw Eye for 79790.....
200383C	20807	Thread Unwinder Spool Rest Rod Set Screw for 202490.....
201018C	20807	Thread Unwinder Spool Rest Set Screw, for 225257 and 225259.....
201696J	20807	Thread Unwinder Thread Guide Lock Nut, for 150178.....
202490	20778	Thread Unwinder Spool Stand with 200383C for 150178.....
225257	20778	Thread Unwinder Spool Rest (for two spools) with 201018C, for 150178....
225259	20778	Thread Unwinder Spool Rest (for one spool) with 201018C, for 150178....
225322	20807	Thread Unwinder Thread Guide Rod Washer, for 225324.....
225324	20778	Thread Unwinder Thread Guide Rod with 208E and 225322, for 150178.....
225326	20807	Thread Unwinder Thread Guide Position Cup, for 150178.....
225388	20778	Thread Unwinder Spool Rest Rod, for 150178.....
225390	20778	Thread Unwinder Thread Cone Holder, for inverted cones.....
225391	20778	Thread Unwinder Thread Guide, for 150178.

PLATE 5566—ONE-HALF SIZE

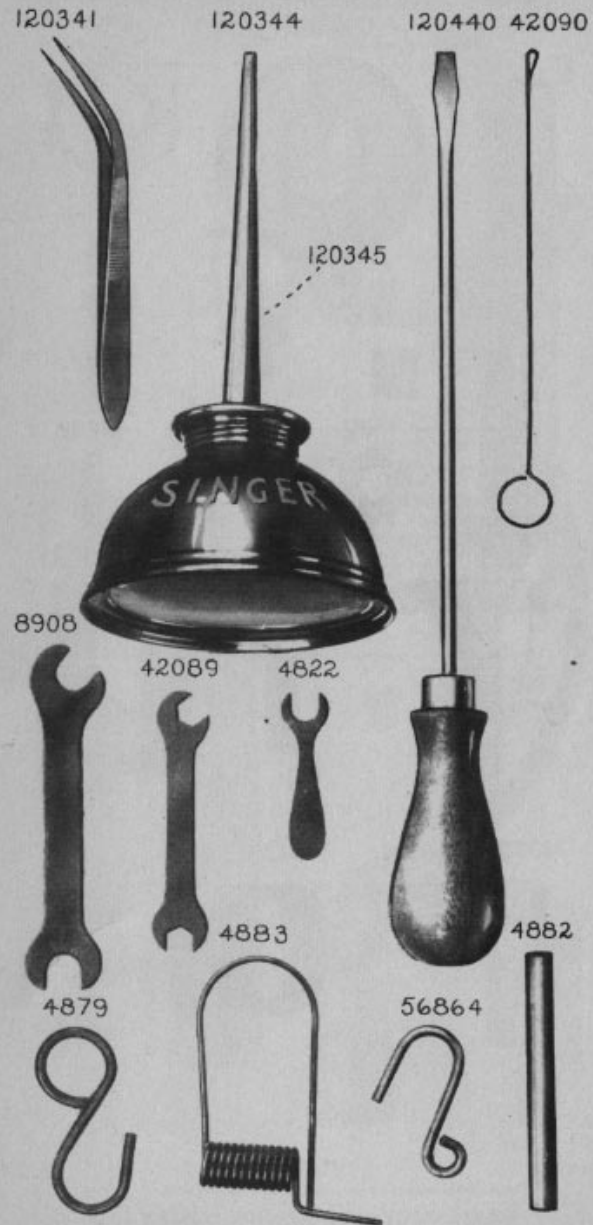


PLATE 5569—FULL SIZE

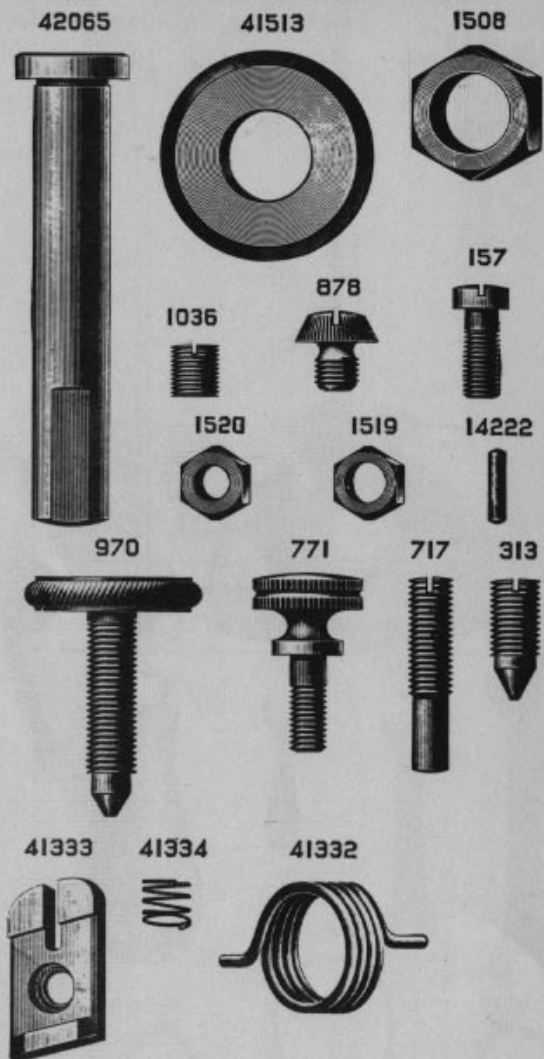
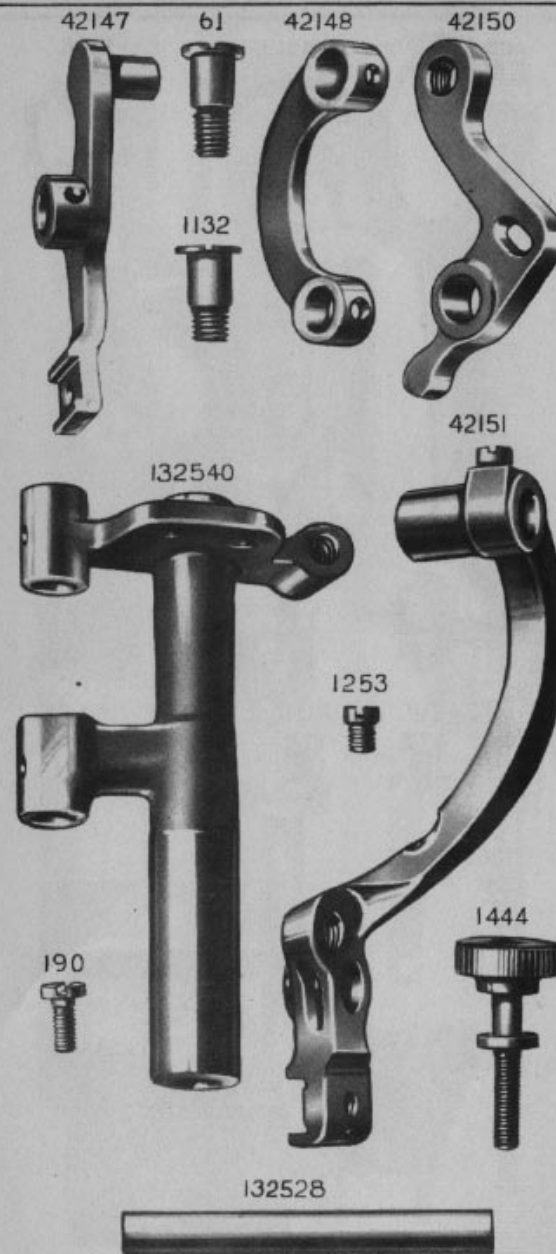


PLATE 7406—FULL SIZE

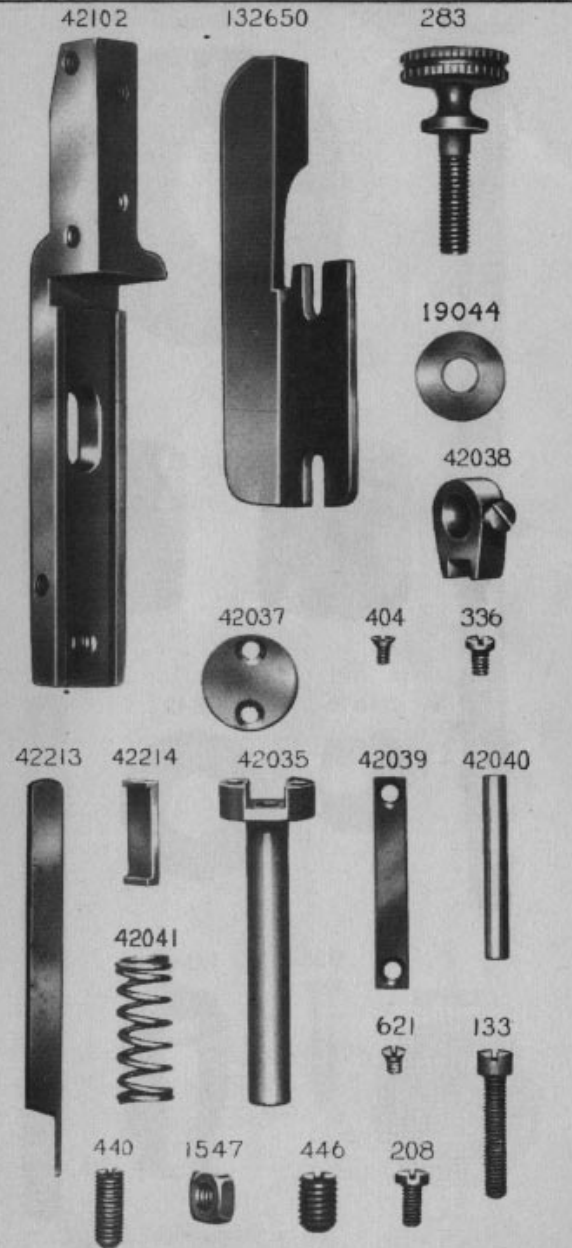


From the library of: Diamond Needle Corp

PLATE 7407—FULL SIZE



PLATE 7409—FULL SIZE



From the library of: Diamond Needle Corp

PLATE 7419—FULL SIZE

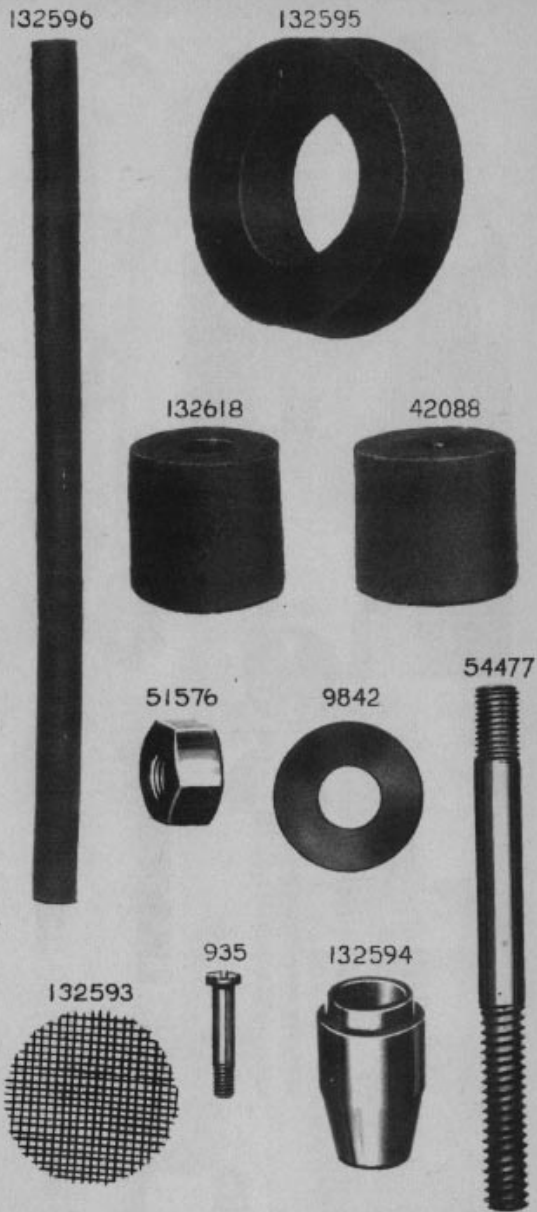
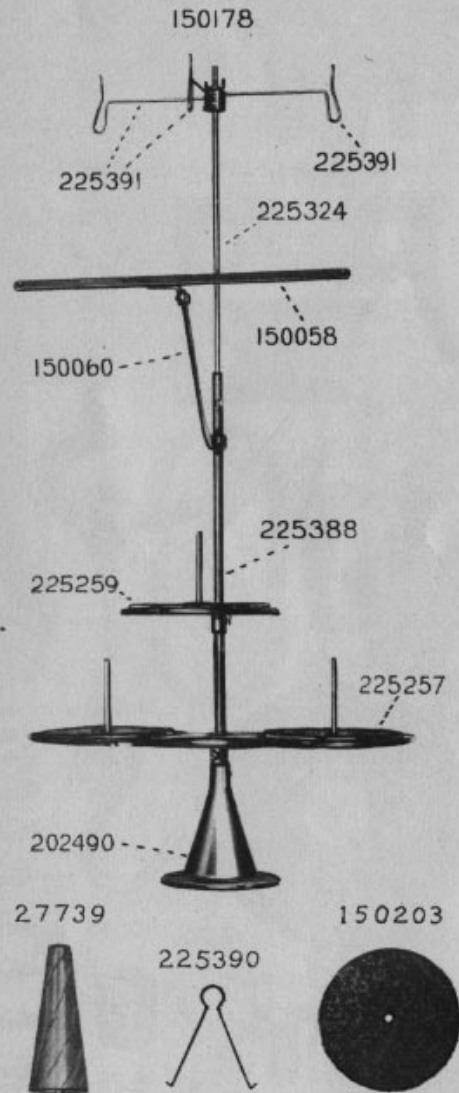


PLATE 20778—ONE-SIXTH SIZE



From the library of: Diamond Needle Corp

PLATE 20807-FULL SIZE

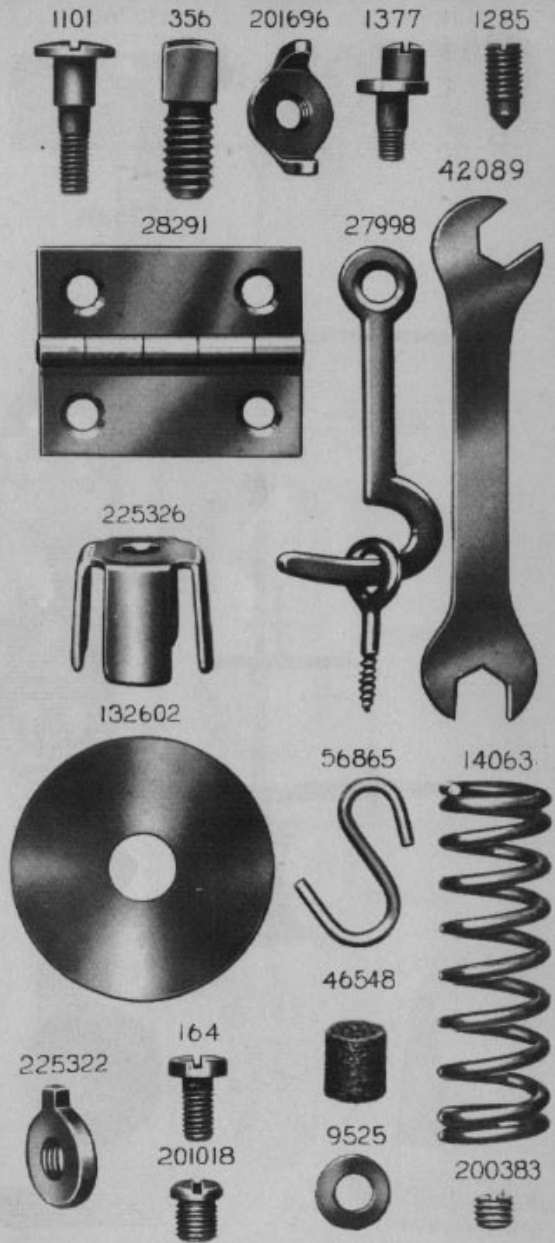
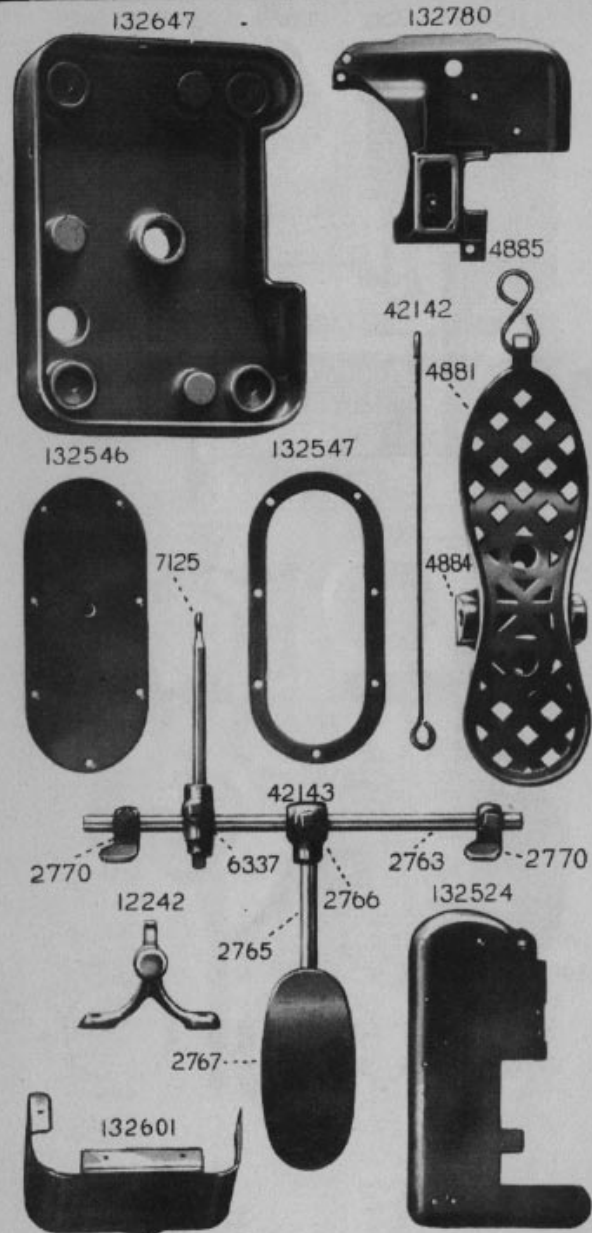


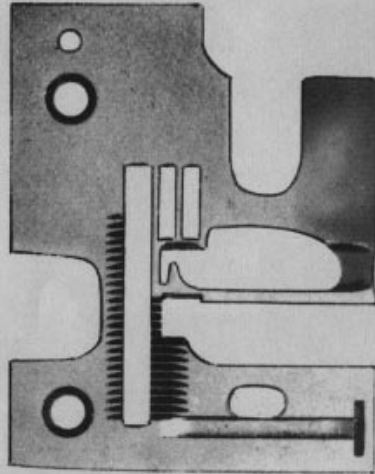
PLATE 20808-ONE-FOURTH SIZE



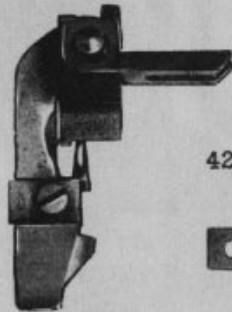
From the library of: Diamond Needle Corp

PLATE 20816-FULL SIZE

42452



42185



42149



42184



42182



14058



9320



42160



233

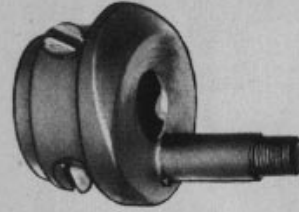


464



PLATE 20817-FULL SIZE

132769



1036



1375



132774



1664



132770



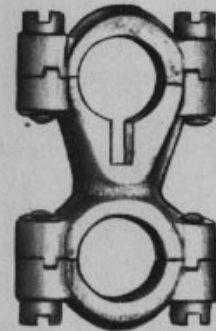
132771



132772



132777



132802



896



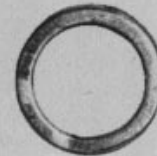
132863



132715



132835



From the library of: Diamond Needle Corp

PLATE 20818-FULL SIZE

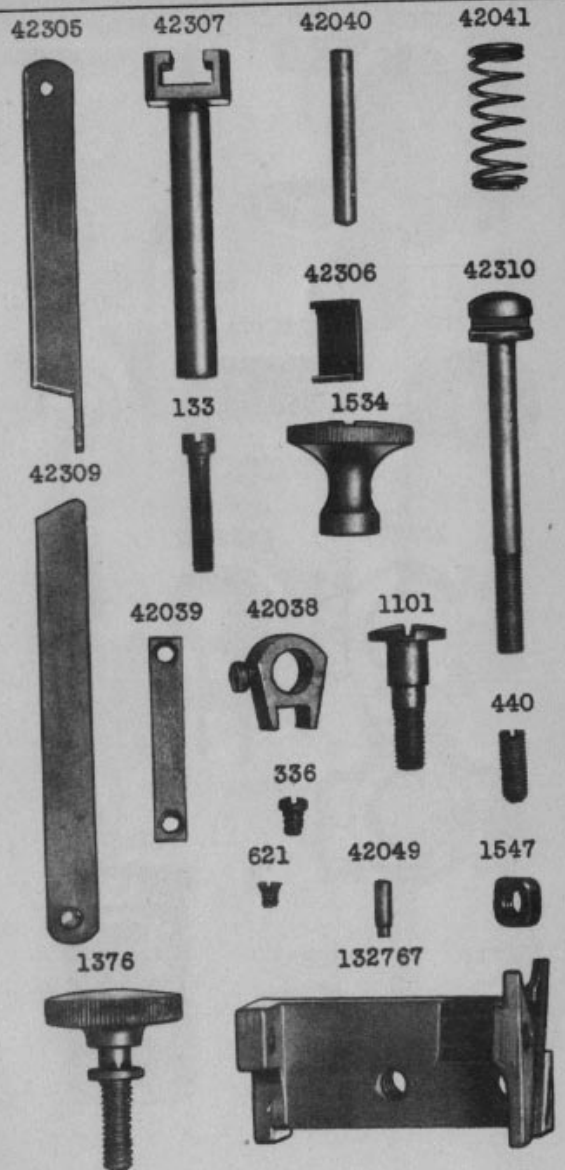
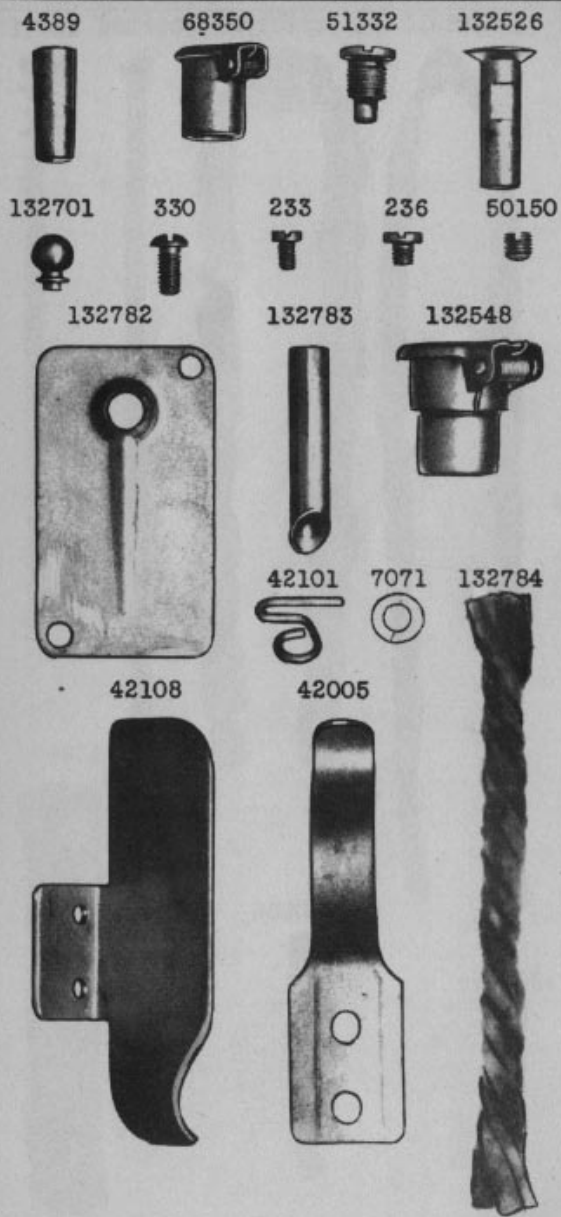


PLATE 20821-FULL SIZE



From the library of: Diamond Needle Corp

PLATE 20823-FULL SIZE

132816 132817 132864 132868



132867

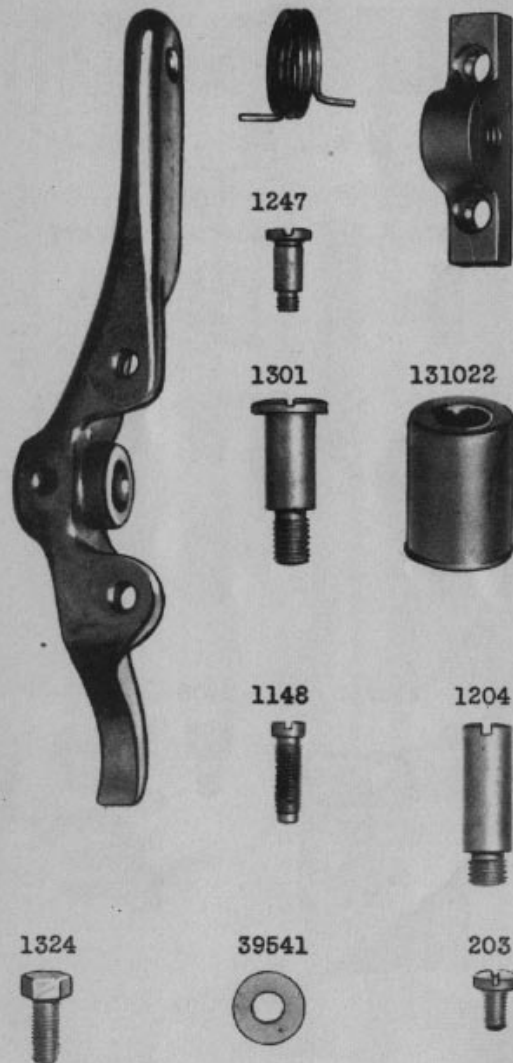
132558

132559



PLATE 20824-FULL SIZE

42130 42132 42131



From the library of: Diamond Needle Corp

PLATE 20825-FULL SIZE

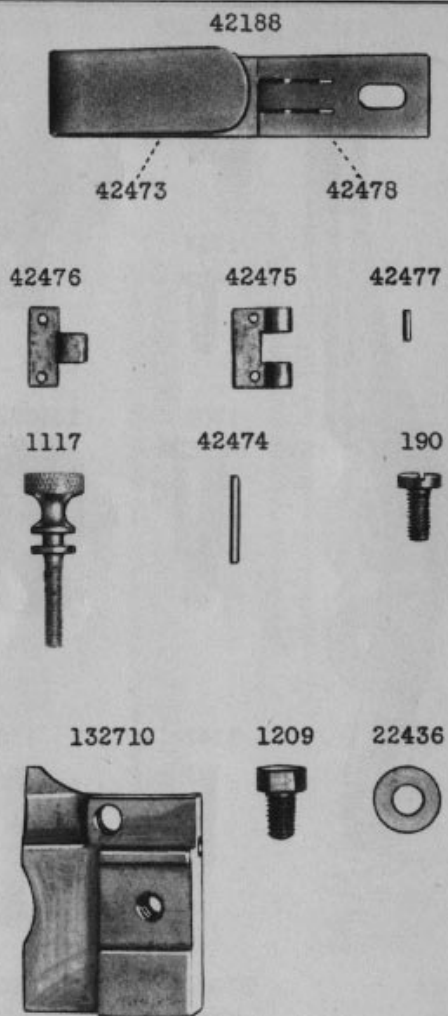


PLATE 20826-FULL SIZE

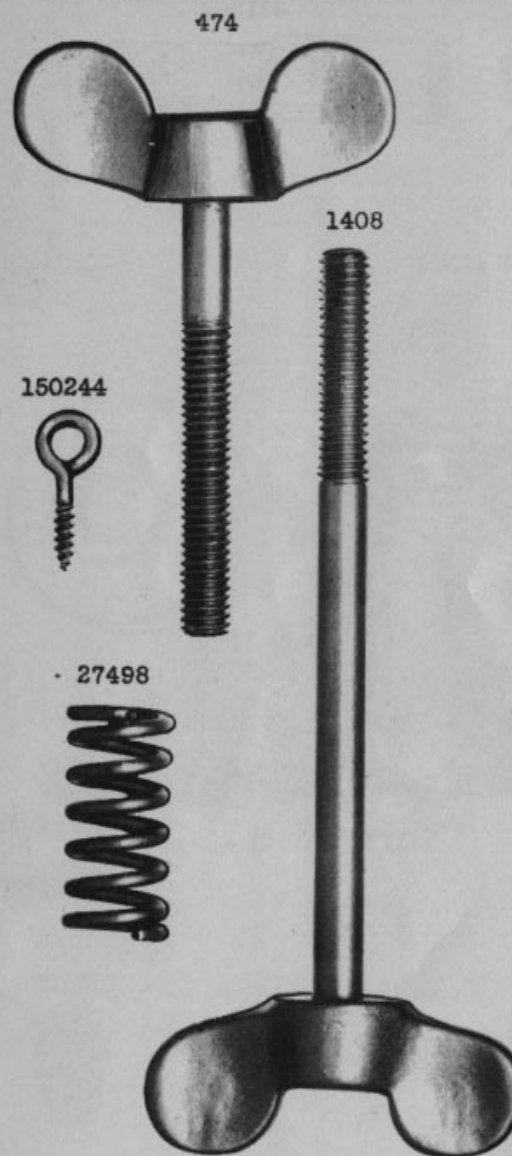
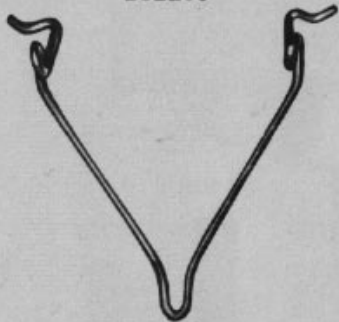


PLATE 20828-ONE-HALF SIZE

131189



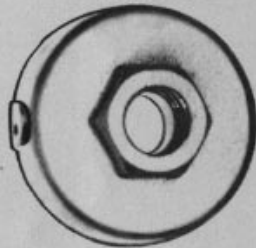
131265



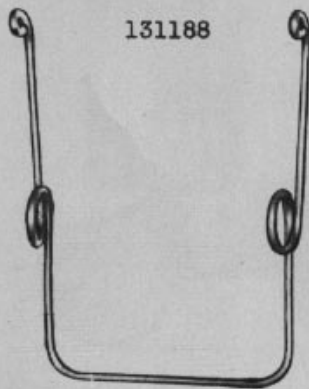
131185



131191



131188



131267

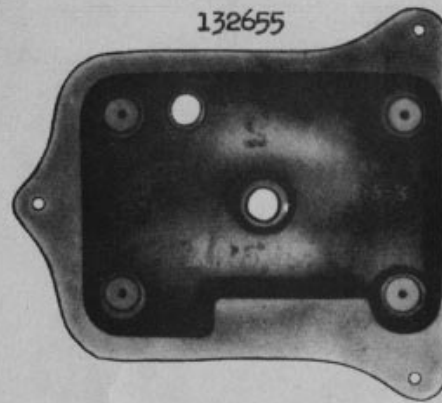


131266



PLATE 20830-ONE-FOURTH SIZE

132655



41329

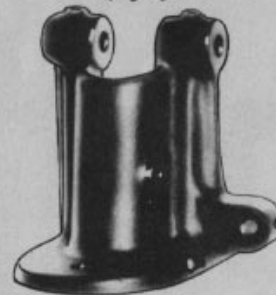


PLATE 20834 - FULL SIZE

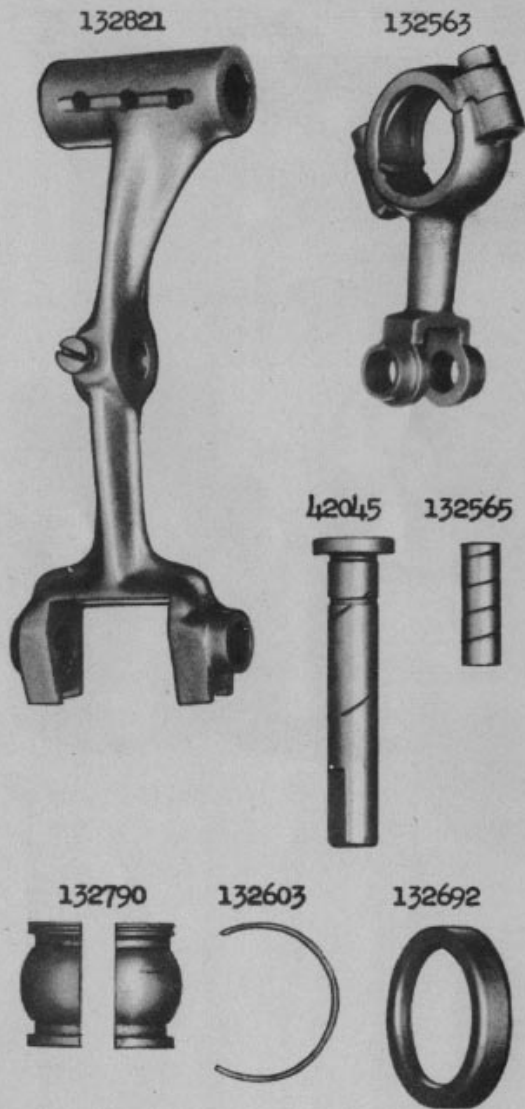


PLATE 20839 - FULL SIZE

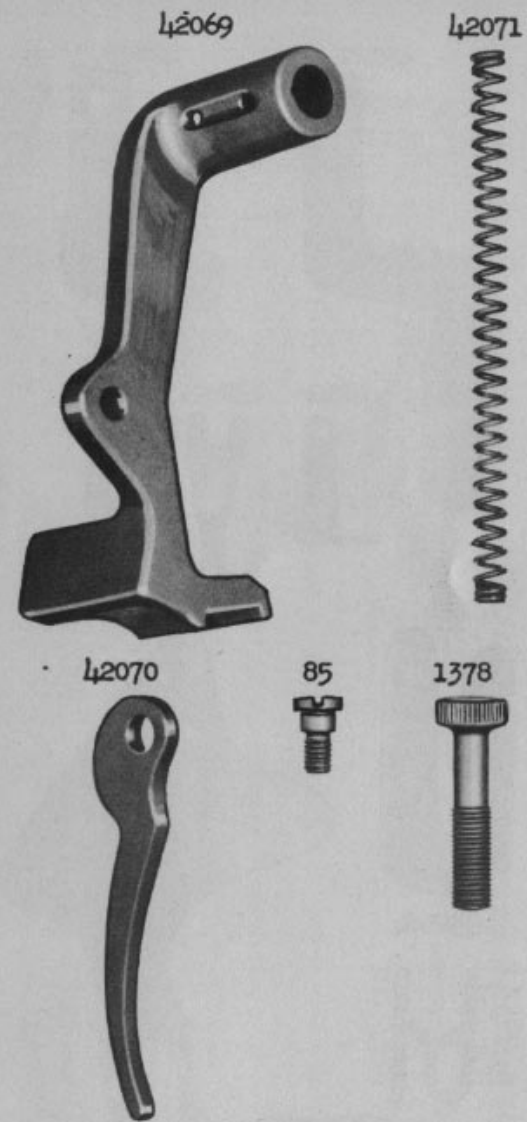


PLATE 20844 - FULL SIZE

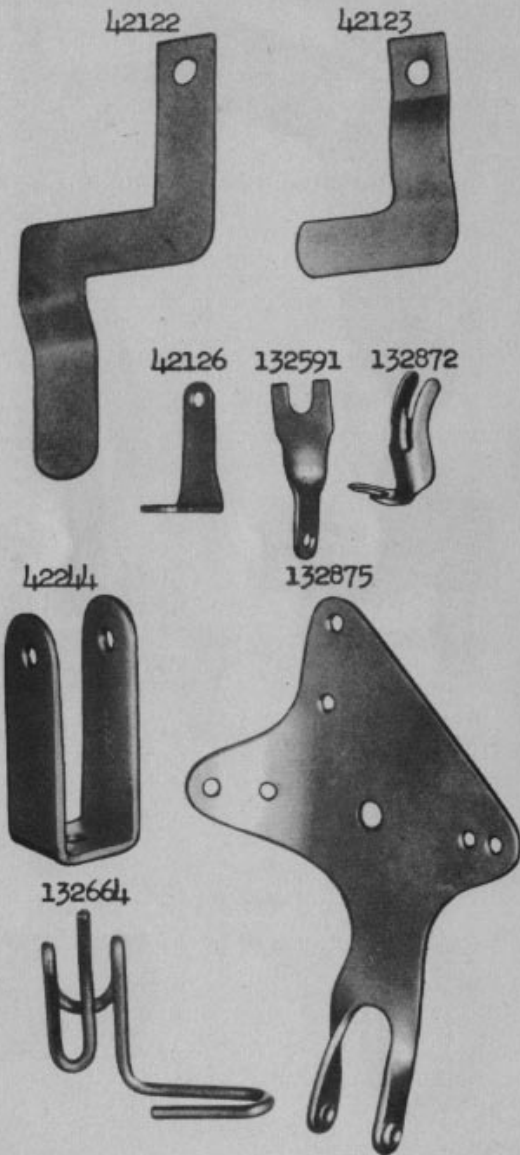
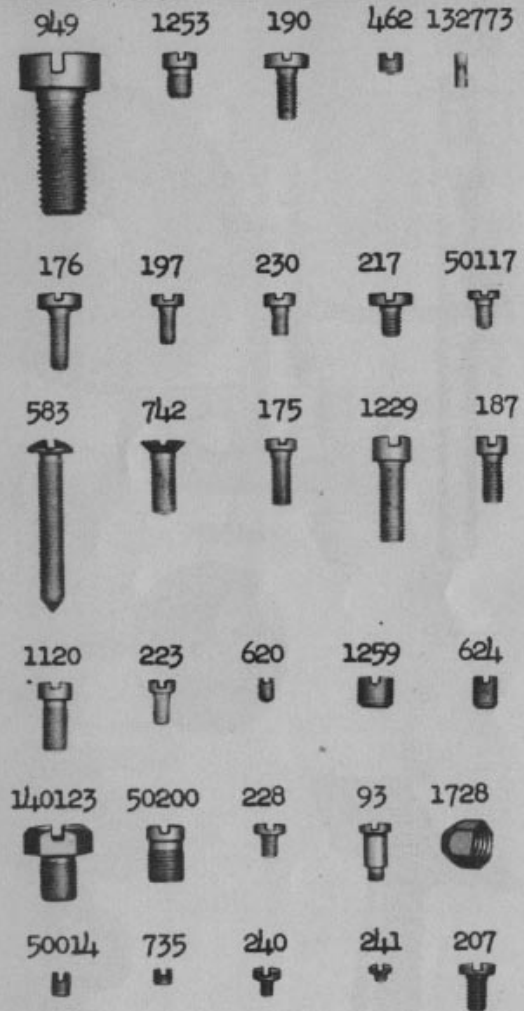


PLATE 20846 - FULL SIZE



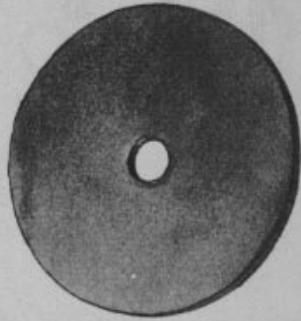
From the library of: Diamond Needle Corp

PLATE 20847 - ONE-HALF SIZE

41327



41326



41328



41818

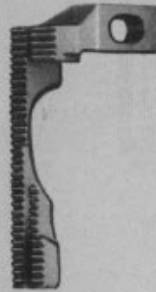


41331

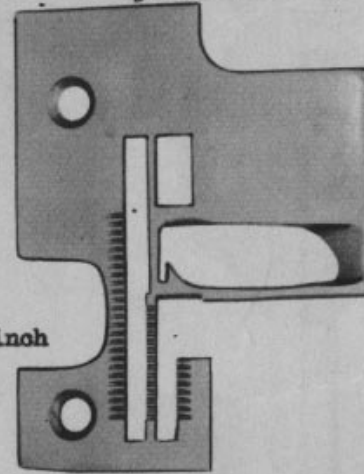


PLATE 20853 - FULL SIZE

132859

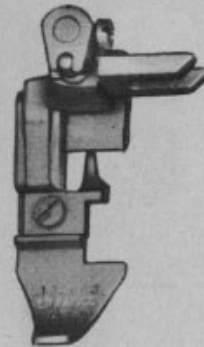


132861



22 teeth = 1 inch

132860



132608



PLATE 20855 - ONE-HALF SIZE

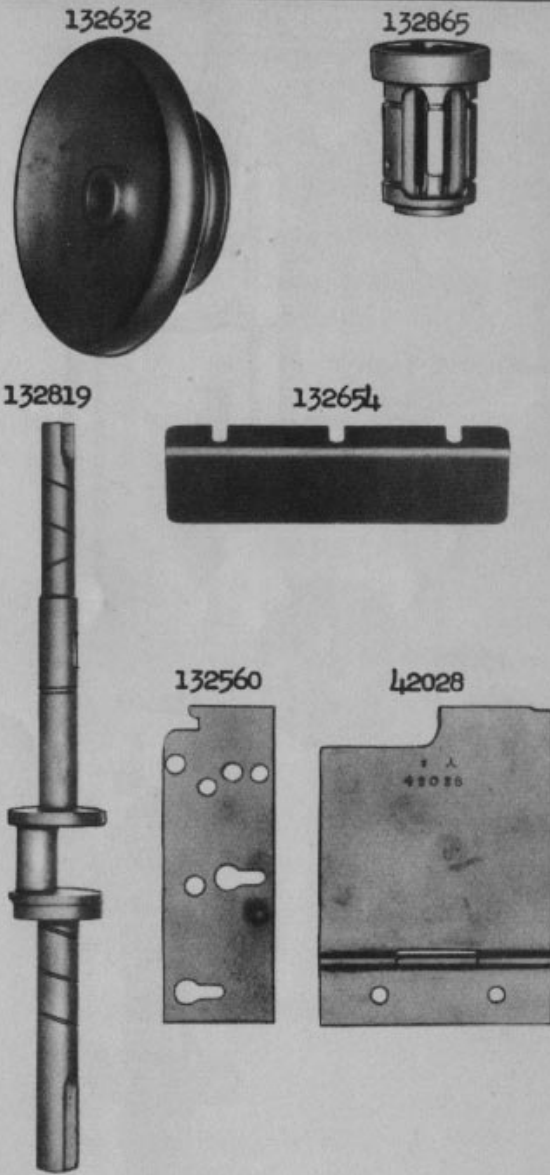
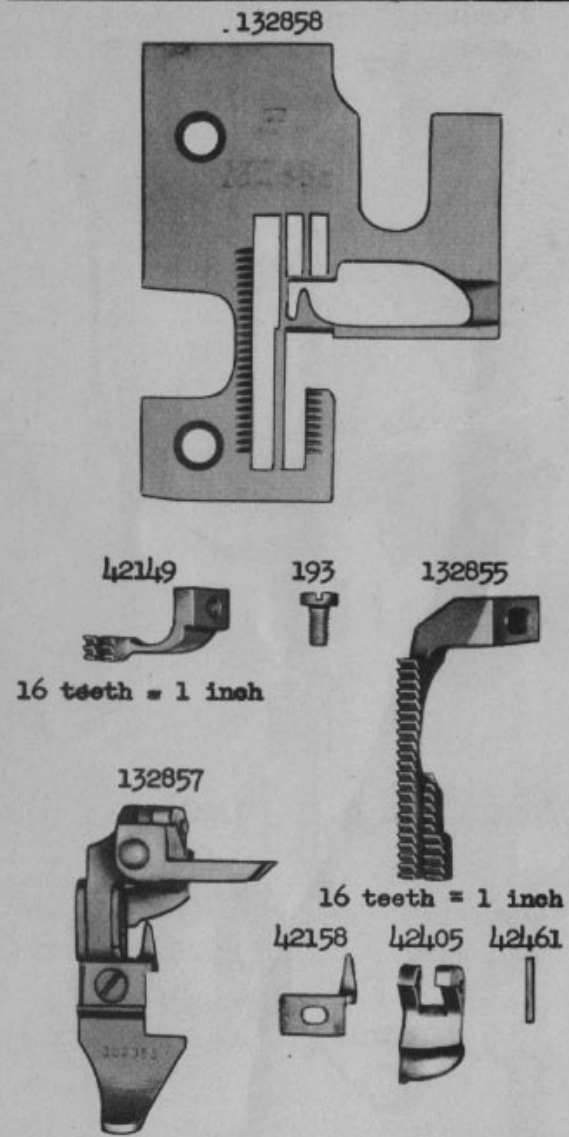


PLATE 20856 - FULL SIZE



From the library of: Diamond Needle Corp

PLATE 20857 - FULL SIZE

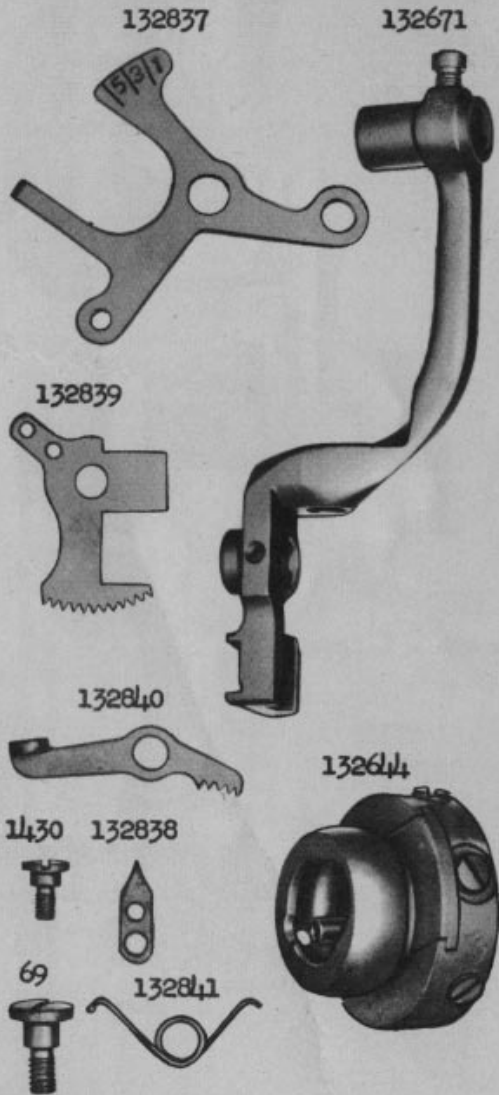
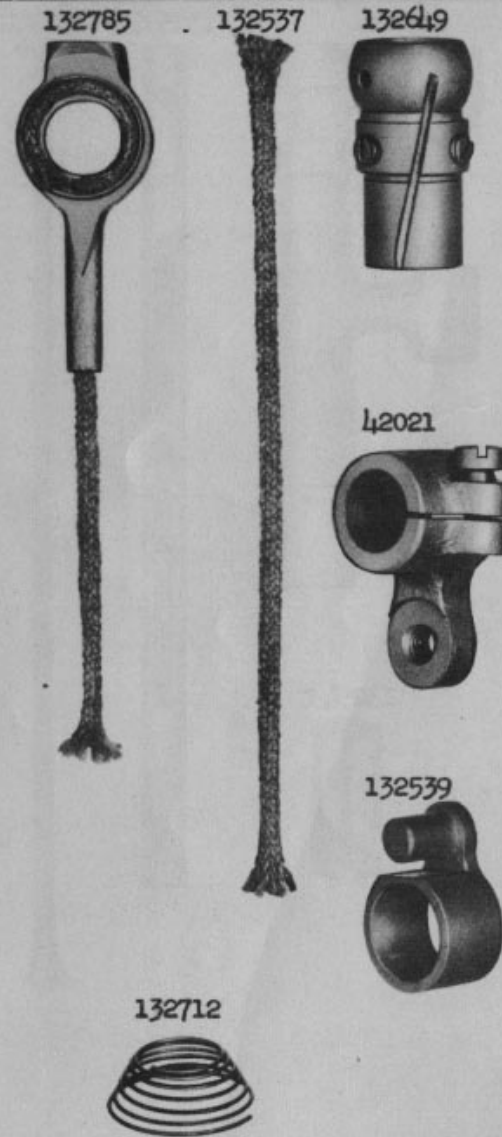


PLATE 20858 - FULL SIZE



From the library of: Diamond Needle Corp

PLATE 20859 - FULL SIZE

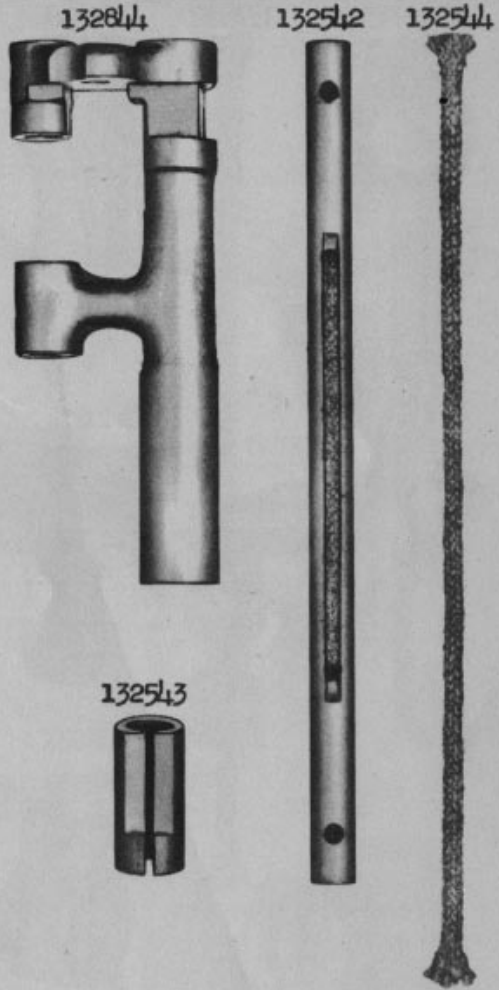


PLATE 20860 - FULL SIZE

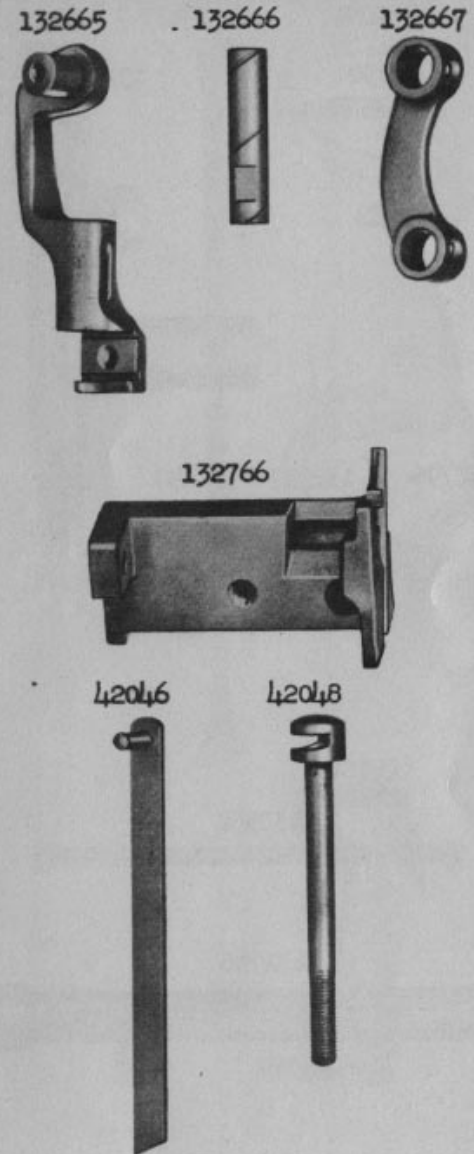


PLATE 20861 - FULL SIZE

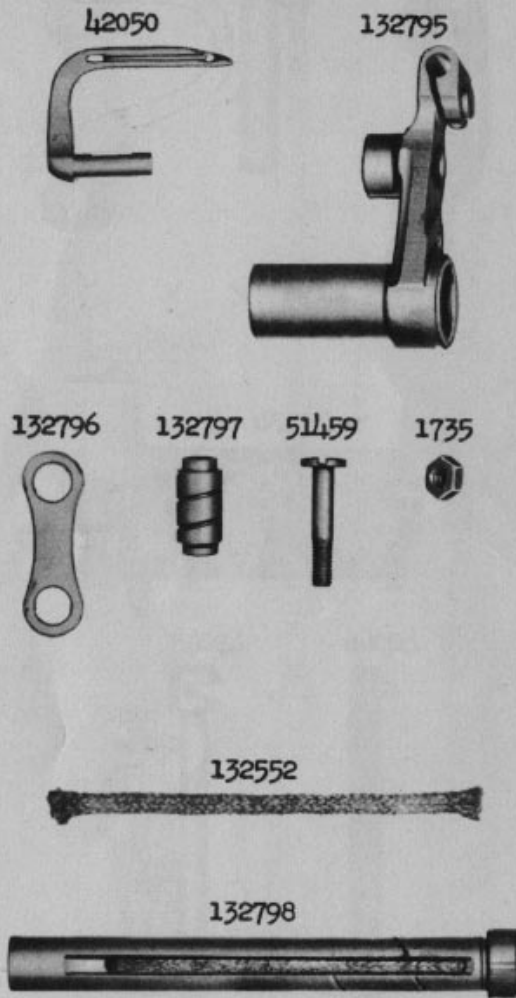


PLATE 20862 - FULL SIZE

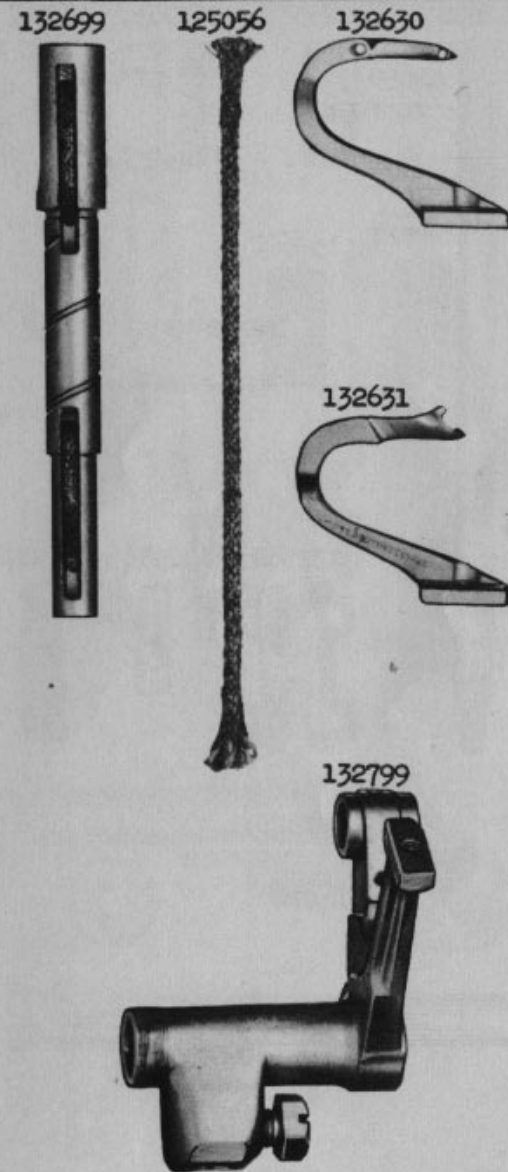


PLATE 20863 - FULL SIZE

42054



42253



132580



132581



132621



132598



132582



132583



132584



42115



42483



10107

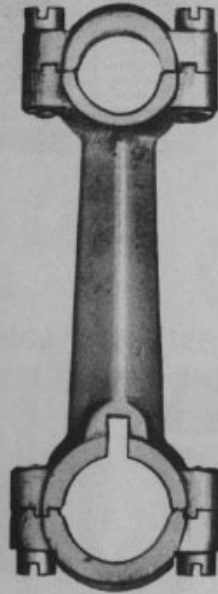


42066



PLATE 20864 - FULL SIZE

132806



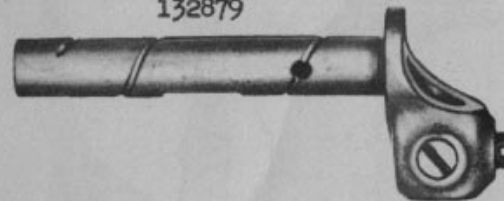
132589



132590



132879



132880

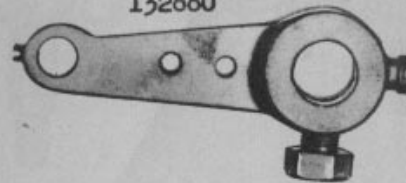
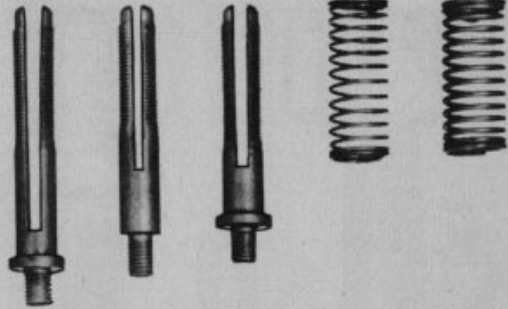
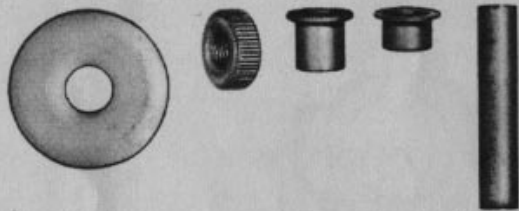


PLATE 20865 - FULL SIZE

50326 50261 50148 59534 59535



2102 51570 59537 59538 42084



132599



132812



185



132873 52130

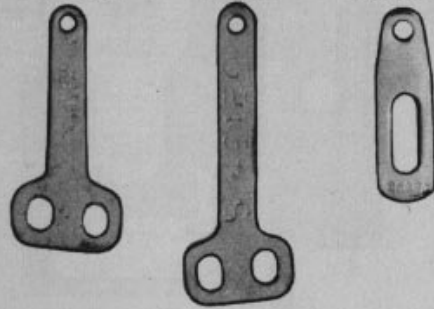


1301



PLATE 20866 - FULL SIZE

132883 42128 42096



57076



42242



132914



42082

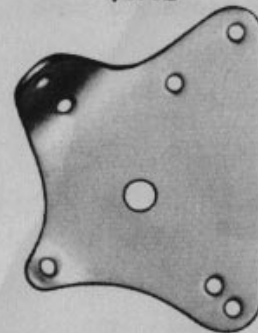
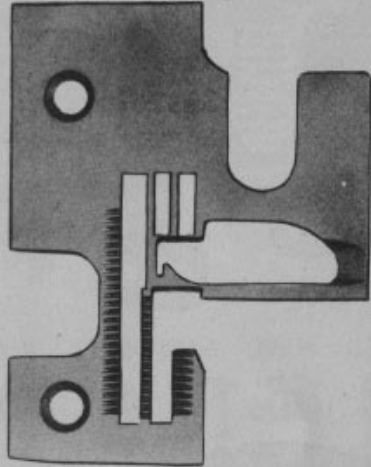


PLATE 20867 - FULL SIZE

132903



42492



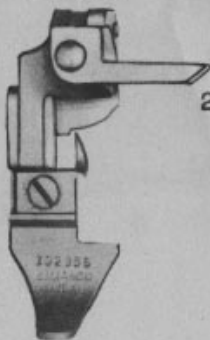
22 teeth = 1 inch

42491



22 teeth = 1 inch

132904

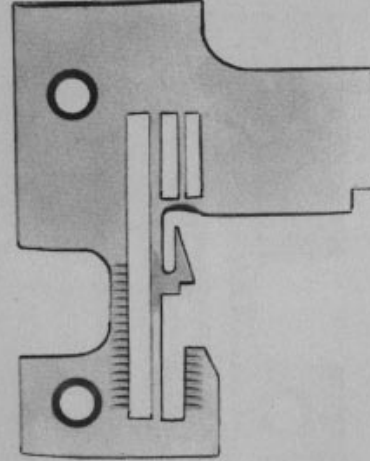


42288



PLATE 20868 - FULL SIZE

132920



132836

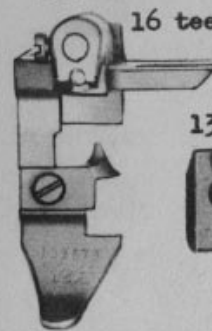


16 teeth = 1 inch

132843

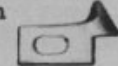


132681



16 teeth = 1 inch

132680



132609



132610

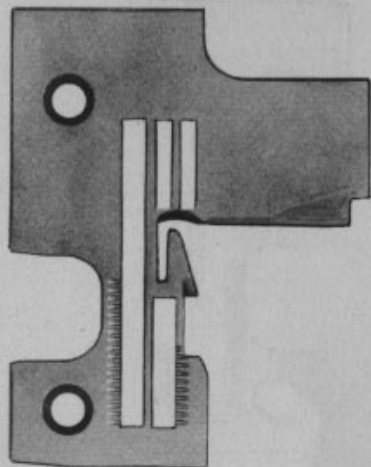


132611

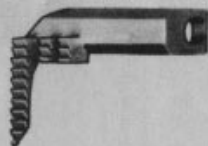


PLATE 20869 - FULL SIZE

132689

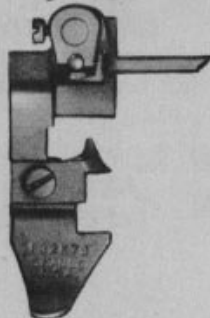


132836



16 teeth = 1 inch

132681



132843



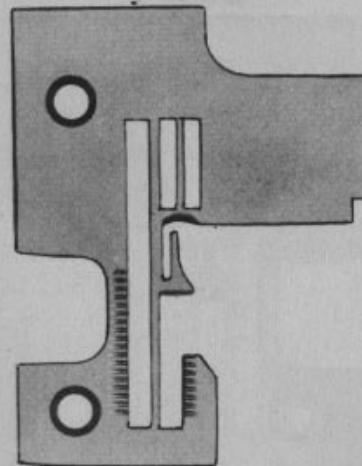
16 teeth = 1 inch

132680

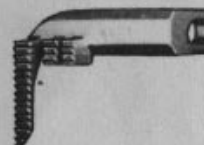


PLATE 20870 - FULL SIZE

132850

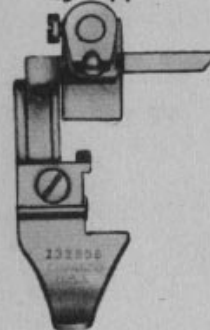


132848



22 teeth = 1 inch

132877



132849



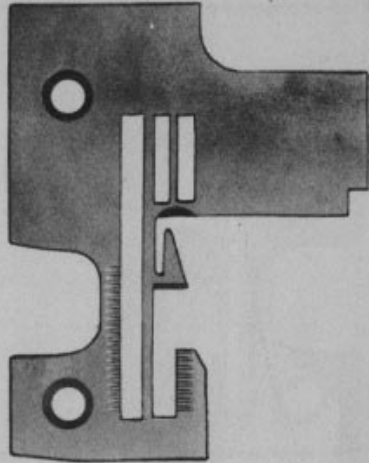
22 teeth = 1 inch

132876

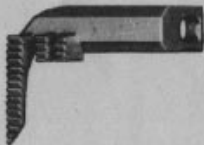


PLATE 20871 - FULL SIZE

132690

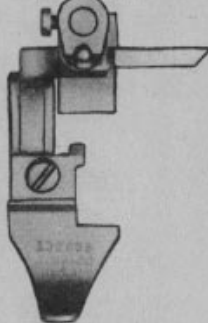


132848



22 teeth = 1 inch

132877



132849



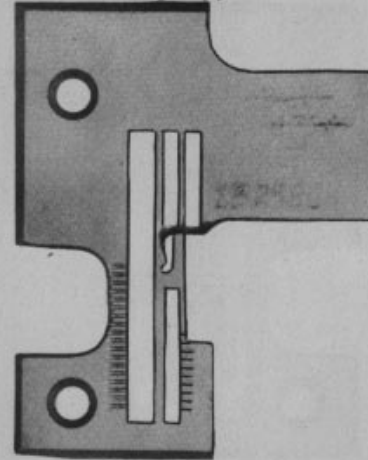
22 teeth - 1 inch

132876



PLATE 20872 - FULL SIZE

132899



132892

16 teeth = 1 inch

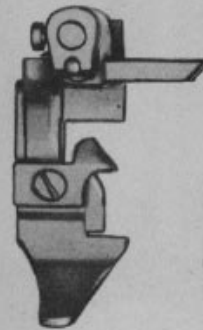


132893

16 teeth = 1 inch



132898



132894



132895

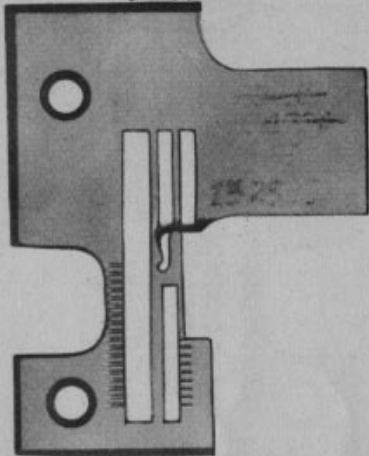


132896



PLATE 20873 - FULL SIZE

132899



132892

16 teeth = 1 inch

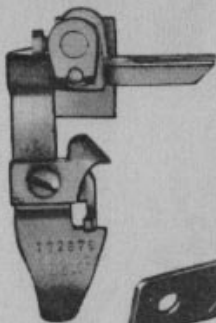


132893

16 teeth = 1 inch



132902



132901



42137



PLATE 20874 - ONE-HALF SIZE

41330



132846

